

Consumable Parts Catalog

2025

- Contact Frontier-lab's channel partners when purchasing the consumable parts listed in this catalog.
<https://www.frontier-lab.com/support/business-partner/>
- Appearance, specifications, and kit contents are subject to change without notice.
- Refer to this catalog for details on the compatibility of parts.

Index

1. Pyrolyzer (EGA/PY-3030D, PY-3030S)	
1.1 Consumable parts set	4
1.2 Pyrolyzer furnace	7
1.3 GC related parts	11
1.4 Common parts	16
2. Capillary Column	17
3. Vent-Free GC/MS Adapter	18
4. Sampling Tool	
4.1 Sample cups	25
4.2 Standard Sample	31
4.3 Magic Chemisorber	31
4.4 Micro Sample Collector	33
4.5 Sampling tools	34
5. Sampler	
5.1 On-line Micro Reaction Sampler	39
5.2 Micro Thermal Desorption Sampler	40
6. Selective Sampler (SS-2010E/1010E)	41
7. Multi-Functional Splitless Sampler (MFS-2015E)	45
8. MicroJet Cryo-Trap (MJT-2030E/1035E)	48
9. Auto-Shot Sampler (AS-2020E/1020E)	55

Index

10. Carrier Gas Selector (CGS-1050Ex)	61
11. Micro-UV Irradiator (UV-1047Xe/UV-1048E)	
11.1 Micro UV Irradiator Xe (UV-1047Xe)	62
11.2 Multi-Sample UV Irradiator (UV-1048E)	64
12. micro-Reactor (Tandem Rx-3050TR, Single Rx-3050SR)	
12.1 Consumable parts set	65
12.2 Tandem Reactor related parts	67
12.3 Single Reactor related parts	70
12.4 micro-Reactor related parts	72
13. Cryogenic Mill (IQ MILL-2070)	79

1. Pyrolyzer (EGA/PY-3030D, PY-3030S)

1.1 Consumable parts set : a set of consumable parts for one year



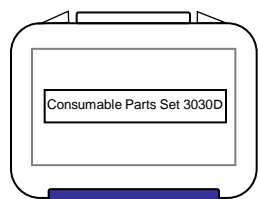







Consumable Parts Set 3030D



P/N: PY-K303D
for EGA/PY-3030D, 1 set

Contents of PY-K303D		Qty
1)	Eco-Cup SF (Sample cup)	100 ea
2)	Eco-Cup LF (Sample cup)	100 ea
3)	Eco-Stand AL (Sample cup stand)	5 ea
4)	Eco Pick-Up F (for sample cup recovery)	5 ea
5)	Eco-Stick SF	50 ea
6)	Eco-Stick DF	50 ea
7)	Needle Set N	8 ea
8)	Septum (for liquid sampler)	10 ea
9)	Quartz Pyrolysis Tube A3030	4 ea
10)	Graphite Vespel Ferrule (for interface)	8 ea

※ Use the following part numbers when ordering the parts individually. The quantities of each parts may differ from the Consumable Parts Set. The quantities of the parts contained in the Consumable Parts Set are shown in the list above.

No.	P/N (part number)	Part name	Specification	Qty	Part
1	PY1-EC50F	Eco-Cup SF	4 mm o.d. x H 5 mm , 50 μ L, made of stainless steel	100 ea	
2	PY1-EC80F	Eco-Cup LF	4 mm o.d. x H 8 mm , 80 μ L , made of stainless steel	100 ea	
3	PY1-EH10AL	Eco-Stand AL	Eco-Cup stand for 1 cup, for all Eco-Cups, made of aluminum	5 ea	
4	PY1-EP55F	Eco Pick-Up F	For stainless steel Eco-Cup recovery, L 135 mm	5 ea	
5	PY1-ES10F	Eco-Stick SF	L 30 mm , for Single-shot	50 ea	
6	PY1-ES20F	Eco-Stick DF	L 80 mm, for Double-shot	50 ea	
7	PY1-1274	Needle Set N	Deactivated needle for PY-3030, PY-2020 and Rx-3050	3 ea	
8	PY1-2025	Septum	For liquid sampler	20 ea	
9	PY1-3018A	Quartz Pyrolysis Tube A3030	For PY-3030, L 120 mm , made of quartz	1 ea	
10	PY1-7911	Graphite Vespel Ferrule	6 mm hole i.d., for interface	5 ea	

1. Pyrolyzer (EGA/PY-3030D, PY-3030S)

1.1 Consumable parts set : a set of consumable parts for one year

Consumable Parts Set 3030AS

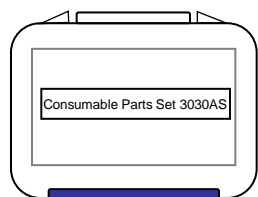







Contents of PY-K313D		Qty
1)	Eco-Cup LF (Sample cup)	300 ea
2)	Needle Set N	8 ea
3)	Quartz Pyrolysis Tube A3030	4 ea
4)	ITF Union ASN (use with Auto-Shot Sampler)	1 set
5)	Eco-Cup Stand 10	2 ea
6)	Graphite Vespel Ferrule (for interface)	8 ea

P/N: PY-K313D

for EGA/PY-3030D or PY-3030S with
Auto-Shot Sampler AS-1020E, 1 set

※ Use the following part numbers when ordering the parts individually. The quantities of each parts may differ from the Consumable Parts Set. The quantities of the parts contained in the Consumable Parts Set are shown in the list above.

No.	P/N (part number)	Part name	Specification	Qty	Part
1	PY1-EC80F	Eco-Cup LF	4 mm o.d. x H 8 mm , 80 μ L, made of stainless steel	100 ea	
2	PY1-1274	Needle Set N	Deactivated needle for PY-3030, PY-2020 and Rx-3050	3 ea	
3	PY1-3018A	Quartz Pyrolysis Tube A3030	For PY-3030, L 120 mm , made of quartz	1 ea	
4	PY1-3533	ITF Union ASN	Interface union assembly for use with Auto-Shot Sampler, deactivated, compatible with PY-2020/3030, Carrier gas union set, wrench 6 mm	1 set	
5	PY1-3711	Eco-Cup Stand 10	For Eco-Cup LF and Eco-Cup G/GQ, for 10 cups	1 ea	
6	PY1-7911	Graphite Vespel Ferrule	6 mm hole i.d., for interface	5 ea	

1. Pyrolyzer (EGA/PY-3030D, PY-3030S)

1.1 Consumable parts set : a set of consumable parts for one year



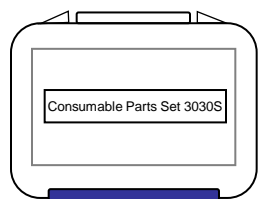





Consumable Parts Set 3030S



P/N: PY-K303S
for PY-3030S, 1 set

Contents of PY-K303S		Qty
1)	Eco-Cup SF (Sample cup)	100 ea
2)	Eco-Cup LF (Sample cup)	100 ea
3)	Eco-Stand AL (Sample cup stand)	5 ea
4)	Eco Pick-Up F (for sample cup recovery)	5 ea
5)	Eco-Stick SF	100 ea
6)	Needle Set N	8 ea
7)	Septum (for liquid sampler)	10 ea
8)	Quartz Pyrolysis Tube A3030	4 ea
9)	Graphite Vespel Ferrule (for interface)	8 ea

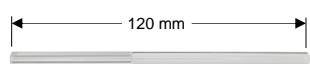
※ Use the following part numbers when ordering the parts individually. The quantities of each parts may differ from the Consumable Parts Set. The quantities of the parts contained in the Consumable Parts Set are shown in the list above.

No.	P/N (part number)	Part name	Specification	Qty	Part
1	PY1-EC50F	Eco-Cup SF	4 mm o.d. x H 5 mm , 50 μ L, made of stainless steel	100 ea	
2	PY1-EC80F	Eco-Cup LF	4 mm o.d. x H 8 mm , 80 μ L, made of stainless steel	100 ea	
3	PY1-EH10AL	Eco-Stand AL	Eco-Cup stand for 1 cup, for all Eco-Cups, made of aluminum	5 ea	
4	PY1-EP55F	Eco Pick-Up F	For stainless steel Eco- Cup recovery, L 135 mm	5 ea	
5	PY1-ES10F	Eco-Stick SF	L 30 mm , for Single-shot	50 ea	
6	PY1-1274	Needle Set N	Deactivated needle for PY-3030, PY-2020 and Rx-3050	3 ea	
7	PY1-2025	Septum	For liquid sampler	20 ea	
8	PY1-3018A	Quartz Pyrolysis Tube A3030	For PY-3030, L 120 mm , made of quartz	1 ea	
9	PY1-7911	Graphite Vespel Ferrule	6 mm hole i.d., for interface	5 ea	

1. Pyrolyzer (EGA/PY-3030D, PY-3030S)

1.2 Pyrolyzer Furnace

Note: Some parts are only compatible with the PY-3030 or PY-2020 series.
The dedicated parts for PY-2020 series were discontinued on Dec. 31, 2020.

Furnace and Interface Parts

Common Parts

P/N (part number)	Part name	Specification	Qty	Part
PY1-7811	O-ring (P-12)	O-ring for sampler base of PY-2020iD/iS and PY-3030D/S, black	10 ea	

PY-3030D/S Parts

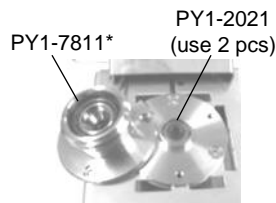

PY-3030D/S pyrolysis tube sealing

P/N (part number)	Part name	Specification	Qty	Part
PY1-2021*	O-ring (P-6R) <small>*Replacement of PY1-2017 (O-ring P-6W).</small>	Pyrolysis tube sealing Red silicon rubber	10 ea	

Furnace and Interface Parts

Common parts for PY-3030D/S (Refer to the next page for details)

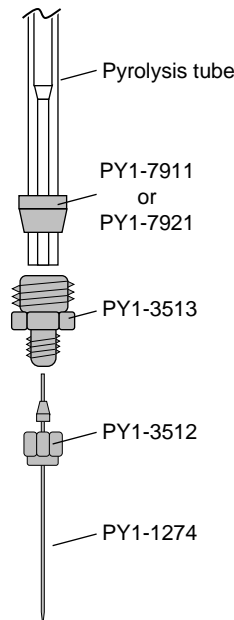

Connection between pyrolysis tube and needle

1. Pyrolyzer (EGA/PY-3030D, PY-3030S)

1.2 Pyrolyzer Furnace

Furnace and Interface Parts

PY-3030D/S Parts

P/N (part number)	Part name	Specification	Qty	Part
PY1-3018A	Quartz Pyrolysis Tube A3030	For PY-3030, L 120 mm , made of quartz	1 ea	
PY1-1274	ITF Needle Set N	Deactivated needle for PY-3030, PY-2020 and Rx-3050	3 ea	
PY1-3512	Needle Nut	Stainless steel 1/16"	3 ea	
PY1-3513	Interface Union N	With nut	1 ea	
PY1-3515	ITF Union N Set	Contains 1 interface union N with a nut and 2 interface needles N	1 set	
PY1-3533	ITF Union ASN	Interface union assembly for use with Auto-Shot Sampler, deactivated, compatible with PY-2020/3030, Carrier gas union set, wrench 6 mm	1 ea	
PY1-7911	Graphite Vespel Ferrule	6 mm hole i.d., for interface	5 ea	
PY1-7921	Graphite Ferrule	6 mm hole i.d.,	5 ea	

1. Pyrolyzer (EGA/PY-3030D, PY-3030S)



1.2 Pyrolyzer Furnace



Heat Sink Adapter Parts (for connection between pyrolyzer and GC inlet)

Depending on the combination of your GC and pyrolyzer, different part is used.

Please make sure to select parts compatible with your GC.

PY-3030D/S

P/N (part number)	Part name	Specification	Qty	Part
PY1-3551	Heat Sink Adapter Kit 3030	Agilent 7890/6890, Shimadzu GC-2030/2010/17A	1 set	
PY1-3552		PerkinElmer Auto system/Clarus GC	1 set	
PY1-3555		Thermo Fisher TRACE/Focus GC	1 set	







P/N (part number)	Part name	Specification	Qty	Part
PY1-3544	Septum Nut Set 3030	Shimadzu GC-2030/2010/17A	1 set	
PY1-3553		Agilent 7890/6890	1 set	
PY1-3556		PerkinElmer Auto system/Clarus GC	1 set	
- *		Thermo Fisher TRACE/Focus GC	-	-

* Ask your GC vendor.



1. Pyrolyzer (EGA/PY-3030D, PY-3030S)

1.2 Pyrolyzer Furnace

Sampler Parts

P/N (part number)	Part name	Specification	Qty	Part
PY1-1020	Double-Shot Sampler	Double-Shot Sampler for PY-2010, 2020, 3030 pyrolyzer	1 ea	
PY1-1040	Single-Shot Sampler	For all Single-Shot pyrolyzer	1 ea	
PY1-2022	Double-Shot Sampler Stand		1 ea	
PY1-2025	Septum	For liquid sampler	20 ea	
PY1-2112	O-ring (P-3)	For the purge valve of Double-Shot sampler	20 ea	
PY1-7412	Needle Guide φ 0.8 A	For liquid sampler 0.8 mm i.d., H 8 mm	1 ea	

GC Inlet Parts

P/N (part number)	Part name	Specification	Qty	Part
PY1-7301	Septum	Surface treated, for Agilent GC and Thermo RACE 1600/1610/1300/1310 GC	5 ea	
PY1-7304	Septum	Surface treated, for Shimadzu GC	5 ea	
PY1-7306	Septum	Surface treated, for Thermo TRACE GC Ultra and Focus GC	5 ea	

ITF Cover Parts

P/N (part number)	Part name	Specification	Qty	Part
PY1-3563	ITF Cover 3030A	Interface cover for EGA/PY-3030D, PY-3030S, Rx-3050TR, Rx-3050SR, includes set screws (3ea)	1 set	

1. Pyrolyzer (EGA/PY-3030D, PY-3030S)

1.3 GC related parts

Tubing

P/N (part number)	Part name	Specification	Qty	Part
PY1-K002	Carrier Gas Union Set 1/8	1/8" union (SS, 1ea), 1/8" nut (SS, 2ea), 1/8" back ferrule (SS, 2ea) and Inlet/outlet septum (5 ea)	1 set	
PY1-K003	Cap Set	1/8" nut (SS, 1ea), 1/8" cap (SS, 1ea), 1/8 back ferrule (SS,1ea) and Inlet/outlet septum (1ea)	1 set	
PY1-2028	Inlet/Outlet Septum	For connecting tubes, with hole	20 ea	
PY1-2216	Absorption Trap Tube	For trap tube only. Packed with activated charcoal	3 ea	
PY1-2218	Absorption Trap Set 7890/6890SV	For Agilent 7890/6890 split vent	1 set	
PY1-2227	Absorption Trap Set 17SV	For Shimadzu GC-2010/2030/17A split vent	1 set	
PY1-2228	Absorption Trap Set for TRACE GC Ultra	For TRACE GC Ultra split vent	1 set	

1. Pyrolyzer (EGA/PY-3030D, PY-3030S)

1.3 GC related parts

Remote Signal Cable (for connection between pyrolyzer controller and GC)

Depending on the combination of your GC and pyrolyzer, different remote signal cable is used. Please make sure to select a part compatible with your GC.

PY-3030D/S

P/N (part number)	Part name	Specification	Qty	Part
PY1-6111	Remote Signal Cable 3030A78	Agilent 7890/6890	1 ea	
PY1-6121	Remote Signal Cable 3030S20	Shimadzu GC-2030/2010	1 ea	
PY1-6122	Remote Signal Cable 3030S17	Shimadzu GC-17A	1 ea	
PY1-6131	Remote Signal Cable 3030T01	Thermo Fisher TRACE GC	1 ea	
PY1-6151	Remote Signal Cable 3030P01	PerkinElmer Auto system/Clarus GC	1 ea	
PY1-6171	Remote Signal Cable 3030J01	Master GC	1 ea	

1. Pyrolyzer (EGA/PY-3030D, PY-3030S)





1.3 GC related parts

Furnace Control Cable (for connection between Pyrolyzer furnace and controller)

Depending on the voltage, different furnace control cable is used.

Please make sure to select a part compatible with the voltage.

PY-3030D/S

P/N (part number)	Part name	Specification	Qty	Part
PY1-6030	Furnace control cable for EGA/PY-3030D-220V model	Furnace control cable for EGA/PY-3030D-220V model, 1.5m	1 ea	
PY1-6040	Furnace control cable 3030K220	Furnace control cable for EGA/PY-3030D-220V model, noise filter 19 (2 ea), 1.5m	1 ea	
PY1-6031	Furnace control cable for EGA/PY-3030D-110V model	Furnace control cable for EGA/PY-3030D-110V model, 1.5m	1 ea	
PY1-6041	Furnace control cable 3030K110	Furnace control cable for EGA/PY-3030D-110V model, noise filter 19 (2 ea), 1.5m	1 ea	

1. Pyrolyzer (EGA/PY-3030D, PY-3030S)

1.3 GC related parts

Power Cable (Pyrolyzer and Accessory)

Depending on the country / region, different power cable is used.

Please make sure to select a part compatible with your country / region.

P/N (part number)	Part name	Specification	Qty	Part
PY1-7001	AC Power Cable 100V for UL standard	AC Power Cable 100-120V for UL standard, includes noise filter 09 (1 ea)	1 ea	
PY1-7002	AC Power Cable 200V for VDE standard	AC Power Cable 200-240V for VDE standard	1 ea	
PY1-7022	AC Power Cable 200VF for VDE standard	AC Power Cable 200-240V for VDE standard, includes noise filter 13 (1 ea)	1 ea	
PY1-7024	(For China only) AC Power Cable 200V for CCC standard	(For China only) AC Power Cable 200-240V for CCC standard	1 ea	
PY1-7025	(For China only) AC Power Cable 200VF for CCC standard	(For China only) AC Power Cable 200-240V for CCC standard, include noise filter 13 (1ea)	1 ea	



1. Pyrolyzer (EGA/PY-3030D, PY-3030S)

1.3 GC related parts



Power Cable (Pyrolyzer and Accessory)

Depending on country / region, different power cable is used.

Please make sure to select a part compatible with your country / region.

P/N (part number)	Part name	Specification	Qty	Part
PY1-7031	(For Korea only) AC Power Cable 200V for KC standard	(For Korea only) AC Power Cable 200-240V, 10A/AC250V, 2 m, for KC standard	1 ea	
PY1-7032	(For Korea only) AC Power Cable 200VF for KC standard	(For Korea only) AC Power Cable 200-240V, 10A/AC250V, 2 m, for KC standard, includes noise filter 13 (1 ea)	1 ea	

Cable parts (Furnace control cable and Power cable)

P/N (part number)	Part name	Specification	Qty	Part
PY1-6034	Noise filter 09	Noise filter 09, i.d. 9 mm	1 ea	
PY1-6035	Noise filter 19	Noise filter 19, i.d. 19 mm	1 ea	
PY1-6036	Noise filter 13	Noise filter 13, i.d. 13 mm	1 ea	



1. Pyrolyzer (EGA/PY-3030D, PY-3030S)

1.4 Common parts

P/N (part number)	Part name	Specification	Qty	Part
PY1-EH10AL	Eco-stand AL	Eco-Cup stand for 1 cup, for all Eco-Cups, made of aluminum	5 ea	
PY1-EP55F	Eco-Pickup F	For stainless steel Eco-Cup recovery, L 135 mm	5 ea	
PY1-3711	Eco-Cup Stand 10	For Eco-Cup LF and Eco-Cup G/GQ, for 10cups	1 ea	
PY1-4908	Polystyrene sample	For Pyrolyzer Performance Evaluation, Polystyrene 2.5 mg film, Me-stearate 5 w% in 2mL glass bottle	1 ea	
PY1-7111	Hex Screwdriver (2 mm)	2.0 mm	1 ea	
PY1-7114	Double Head Wrench	Wrench 12-14 mm	1 ea	
PY1-7131	Level Vial		1 ea	
PY1-7141	Tweezers	L 125 mm	1 ea	
UA5-30M-0.25F	Ultra ALLOY® Capillary column	dimethylpolysiloxane, 30 m, 0.25 mm i.d., 0.25 um	1 ea	
UADTM-2.5N	EGA Capillary Tube	For Evolved gas analysis, 2.5 m , 0.15 mm i.d.	1 ea	

2. Capillary column

Common parts

P/N (part number)	Part name	Specification	Qty	Part
UAP-7001	File for Ultra ALLOY Capillary Tube	File for cutting capillary tubes	1 ea	
UAP-7002	Ceramic Cutter	W 40 x H 25 mm, thickness 1 mm	5 ea	



Capillary column

P/N (part number)	Part name	Specification	Qty	Part
UA5-30M-0.25F	Ultra ALLOY® Capillary column	dimethylpolysiloxane, 30 m, 0.25 mm i.d., 0.25 µm	1 ea	

3. Vent-free GC/MS Adapter

Vent-free GC/MS Adapter

Common parts





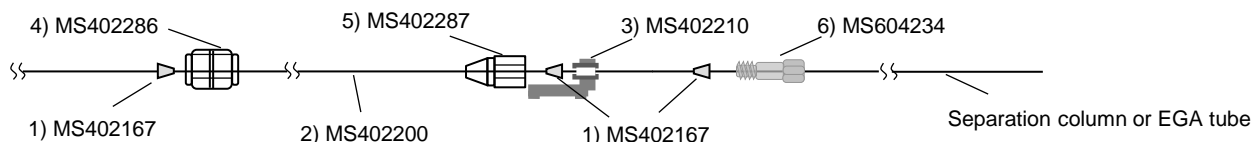

P/N (part number)	Part name	Specification	Qty	Part
UAP-7001	File for Ultra ALLOY Capillary Tube	File for cutting capillary tubes	1 ea	
UAP-7002	Ceramic Cutter	W 40 x H 25 mm, thickness 1 mm	5 ea	

3. Vent-free GC/MS Adapter

Connecting VF tube and Separation column (or EGA tube)

For Agilent, Shimadzu JEOL and Thermo TRACE 1600/1610/1300/1310



No.	P/N (part number)	Part name	Specification	Qty	Part
1	MS402167	VF Metal Ferrule D	VF Metal Ferrule D for column connection	20 ea	
2	MS402200	VF Tube N-50	Includes Vent-free tube N (0.15 mm id / 50 cm, 1 ea), VF spacer, VF metal ferrule D (2 ea), VF nut B and VF nut C	1 set	
3	MS402210	VF Holder N	Use with VF Tube N, consists of holder and fixing bracket	1 set	
4	MS402286	VF Nut B	For the interface between MS and VF tube	3 ea	
5	MS402287	VF Nut C	For the interface between VF Holder N and VF tube	3 ea	
6	MS604234	Column Nut	0.5 mm hole i.d.	1 ea	

※Refer to the next page for Vent-free GC/MS Adapter Kit.

3. Vent-free GC/MS Adapter

Vent-free GC/MS Adapter N-50

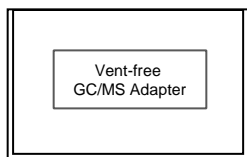









P/N: MS402280

For Agilent, Shimadzu, JEOL and Thermo TRACE 1600/1610/1300/1310
1 set

Contents of MS402280		Qty
1)	Plug Nut B	1 set
2)	VF Metal Ferrule D	10 ea
3)	VF Tube N-50	2 ea
4)	VF Holder N	1 ea
5)	VF Nut B	1 ea
6)	VF Nut C	1 ea
7)	Column Nut	2 ea
8)	Double Head Wrench (6/8 mm)	2 ea
9)	Operation Manual	1 ea

※ Use the following part numbers when ordering the parts individually. The quantities of each parts may differ from the Vent-free GC/MS Adapter N-50. The quantities of the parts contained in the Vent-free GC/MS Adapter N-50 are shown in the list above.

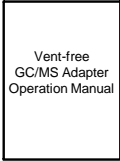
No.	P/N (part number)	Part name	Specification	Qty	Part
1	MS402168	Plug Nut B	Use to plug the VF tube	1 set	
2	MS402167	VF Metal Ferrule D	VF Metal Ferrule D for column connection	20 ea	
3	MS402200	VF Tube N-50	Includes Vent-free tube N (0.15 mm id / 50 cm, 1 ea), VF spacer, VF metal ferrule D (2 ea), VF nut B and VF nut C	1 set	
4	MS402210	VF Holder N	Use with VF Tube N, consists of holder and fixing bracket	1 set	
5	MS402286	VF Nut B	For the interface between MS and VF tube	3 ea	
6	MS402287	VF Nut C	For the interface between VF Holder N and VF tube	3 ea	
7	MS604234	Column Nut		1 ea	
8	Rx1-3532	Double Head Wrench (6/8 mm)	6-8 mm	1 ea	
9	-	Operation Manual	※Not for sale. This can be downloaded from Frontier Lab's website for free.	-	

3. Vent-free GC/MS Adapter

Connecting VF tube and Separation column (or EGA tube)

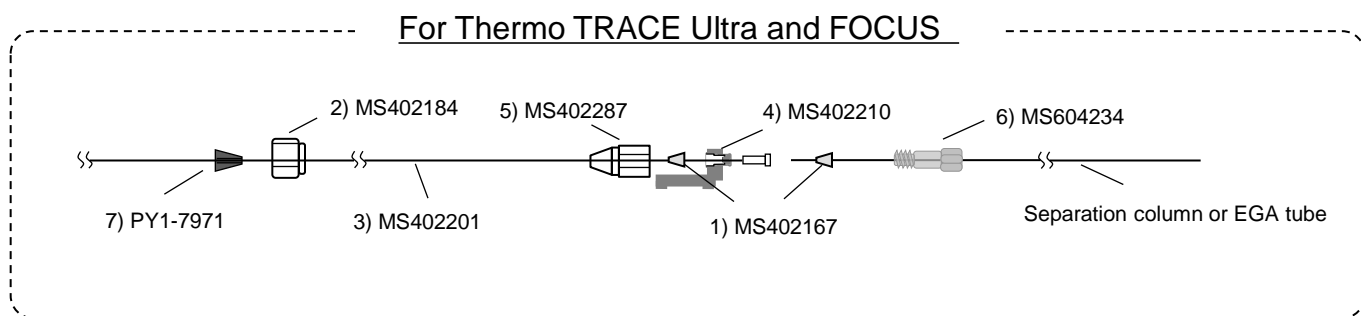

No.	P/N (part number)	Part name	Specification	Qty	Part
1	MS402167	VF Metal Ferrule D	VF Metal Ferrule D for column connection	20 ea	
2	MS402184	VF Nut 1/16	For connecting VF tube to Bruker/Thermo MS interface. 1/16-inch SS, For Thermo Fisher MS	5 ea	
3	MS402201	VF Tube N-70	Includes Vent-free tube N (0.15 mm id / 70 cm, 1 ea), VF spacer, graphite vespel ferrule, VF metal ferrule, 1/16 nut (SS) and VF nut C For Thermo Fisher MS	1 ea	
4	MS402210	VF Holder N	Use with VF Tube N, consists of holder and fixing bracket	1 set	
5	MS402287	VF Nut C	For the interface between VF Holder N and VF tube	3 ea	
6	MS604234	Column Nut		1 ea	
7	PY1-7971	Graphite Vespel Ferrule 05	0.5 mm hole i.d.	10 ea	

※Refer to the next page for Vent-free GC/MS Adapter Kit.

3. Vent-free GC/MS Adapter

Vent-free GC/MS Adapter N-70

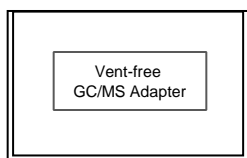

P/N: MS402290
For Thermo TRACE Ultra and
Focus GC
1 set

Contents of MS402290		Qty
1)	Plug Nut B	1 set
2)	VF Metal Ferrule D	10 ea
3)	VF Nut 1/16	1 ea
4)	VF Tube N-70	2 ea
5)	VF Holder N	1 ea
6)	VF Nut C	1 ea
7)	Column Nut	2 ea
8)	Graphite Vespel Ferrule 05	1 ea
9)	Double Head Wrench (6/8 mm)	2 ea
10)	Operation Manual	1 ea

※ Use the following part numbers when ordering the parts individually. The quantities of each parts may differ from the Vent-free GC/MS Adapter N-70. The quantities of the parts contained in the Vent-free GC/MS Adapter N-70 are shown in the list above.

No.	P/N (part number)	Part name	Specification	Qty	Part
1	MS402168	Plug Nut B	Use to plug the VF tube	1 set	
2	MS402167	VF Metal Ferrule D	VF Metal Ferrule D for column connection	20 ea	
3	MS402184	VF Nut 1/16	For connecting VF tube to Bruker/Thermo MS interface. 1/16-inch SS, For Thermo Fisher MS	5 ea	
4	MS402201	VF Tube N-70	Includes Vent-free tube N (0.15 mm id / 70 cm, 1 ea), VF spacer, graphite vespel ferrule, VF metal ferrule, 1/16 nut (SS) and VF nut C For Thermo Fisher MS	1 ea	
5	MS402210	VF Holder N	Use with VF Tube N, consists of holder and fixing bracket	1 set	
6	MS402287	VF Nut C	For the interface between VF Holder N and VF tube	3 ea	
7	MS604234	Column Nut		1 ea	
8	PY1-7971	Graphite Vespel Ferrule 05	0.5 mm hole i.d.	10 ea	
9	Rx1-3532	Double Head Wrench (6/8 mm)	6-8 mm	1 ea	
10	-	Operation Manual	※Not for sale. This can be downloaded from Frontier Lab's website for free.	1 ea	

3. Vent-free GC/MS Adapter

Connecting VF tube and Separation column (or EGA tube)

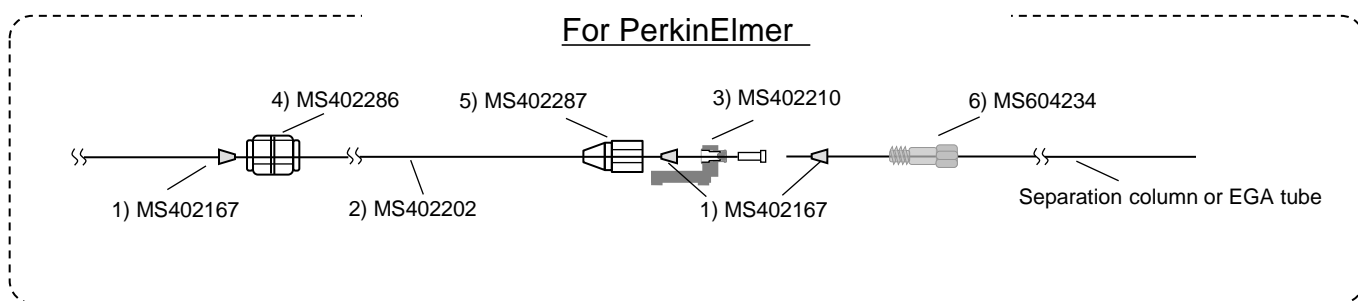

No.	P/N (part number)	Part name	Specification	Qty	Part
1	MS402167	VF Metal Ferrule D	VF Metal Ferrule D for column connection	20 ea	
2	MS402202	VF Tube N-70PE	Includes Vent-free tube N (0.15 mm id / 70 cm, 1 ea), VF spacer, VF metal ferrule D (2ea), VF nut B and VF nut C For PerkinElmer Clarus series	1 ea	
3	MS402210	VF Holder N	Use with VF Tube N, consists of holder and fixing bracket	1 set	
4	MS402286	VF Nut B	For the interface between MS and VF tube	3 ea	
5	MS402287	VF Nut C	For the interface between VF Holder N and VF tube	3 ea	
6	MS604234	Column Nut		1 ea	

※Refer to the next page for Vent-free GC/MS Adapter Kit.

3. Vent-free GC/MS Adapter

Vent-free GC/MS Adapter N-70PE

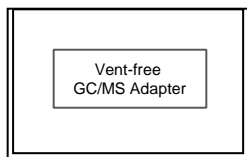









P/N: MS402295

For PerkinElmer,

1 set

Contents of MS402295		Qty
1)	Plug Nut B	1 set
2)	VF Metal Ferrule D	10 ea
3)	VF Tube N-70PE	2 ea
4)	VF Holder N	1 ea
5)	VF Nut B	1 ea
6)	VF Nut C	1 ea
7)	Column Nut	2 ea
8)	Double Head Wrench (6/8 mm)	2 ea
9)	Operation Manual	1 ea

※ Use the following part numbers when ordering the parts individually. The quantities of each parts may differ from the Vent-free GC/MS Adapter N-70PE. The quantities of the parts contained in the Vent-free GC/MS Adapter N-70PE are shown in the list above.

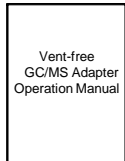
No.	P/N (part number)	Part name	Specification	Qty	Part
1	MS402168	Plug Nut B	Use to plug the VF tube	1 set	
2	MS402167	VF Metal Ferrule D	VF Metal Ferrule D for column connection	20 ea	
3	MS402202	VF Tube N-70PE	Includes Vent-free tube N (0.15 mm id / 70 cm, 1 ea), VF spacer, VF metal ferrule D (2ea), VF nut B and VF nut C For PerkinElmer Clarus series	1 ea	
4	MS402210	VF Holder N	Use with VF Tube N, consists of holder and fixing bracket	1 set	
5	MS402286	VF Nut B	For the interface between MS and VF tube	3 ea	
6	MS402287	VF Nut C	For the interface between VF Holder N and VF tube	3 ea	
7	MS604234	Column Nut		1 ea	
8	Rx1-3532	Double Head Wrench (6/8 mm)	6-8 mm	1 ea	
9	-	Operation Manual	※Not for sale. This can be downloaded from Frontier Lab's website for free.	1 ea	

4. Sampling tool

4.1 Sample Cups





Eco-Cup (Stainless Steel)

P/N (part number)	Part name	Specification	Qty	Part	Part
PY1-EC50F	Eco-Cup SF	4 mm o.d. x H 5 mm , 50 μ L, made of deactivated stainless steel	100 ea		2020iD/iS 3030D/S
PY1-EC80F	Eco-Cup LF	4 mm o.d. x H 8 mm , 80 μ L, made of deactivated stainless steel	100 ea		2020iD/iS 3030D/S
PY1-EC80F-V4	Eco-Cup LF-V4	4 mm o.d. x H 8 mm , 80 μ L, made of deactivated stainless steel	400 ea (100 x 4 bottles)		2020iD/iS 3030D/S
PY1-EC50HF	Flow Through Eco-Cup SHF	Flow through type, 1 mm i.d. hole at the bottom, 4 mm o.d. x H 5 mm , 50 μ L, deactivated stainless steel	20 ea		2020iD/iS 3030D/S
PY1-EC80HF	Flow Through Eco-Cup LHF	Flow though type 1 mm i.d. hole at the bottom, 4 mm o.d. x H 8 mm , 80 μ L, deactivated stainless steel	20 ea		2020iD/iS 3030D/S 7070S
PY1-EC80N	RoHS-Cup LN	Recommended for RoHS phthalates analysis, Non- deactivated stainless steel, max. use temp. 700°C, volume 80 μ L	100 ea		2020iD/iS 3030D/S
PY1-EC80N-V5	RoHS-Cup LN-V5	Recommended for RoHS phthalates analysis, Non- deactivated stainless steel, max. use temp. 700°C, volume 80 μ L, *5 bottles	500 ea (100 x 5 bottles)		2020iD/iS 3030D/S
PY1-EC80N-V10	RoHS-Cup LN-V10	Recommended for RoHS phthalates analysis, Non- deactivated stainless steel, max. use temp. 700°C, volume 80 μ L, *10 bottles	1000 ea (100 x 10 bottles)		2020iD/iS 3030D/S

4. Sampling tool

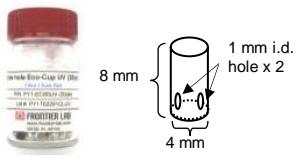
4.1 Sample Cups







Eco-Cup (Stainless Steel)

P/N (part number)	Part name	Specification	Qty	Part	Part
PY1-EC80UV	Side Hole Eco-Cup UV	Flow through type, 1 mm i.d. hole at both sides, 4 mm o.d. x H 8 mm , 80 μ L, deactivated stainless steel	20 ea		2020iD/iS 3030D/S
PY1-EP55F	Eco-Pickup F	For stainless steel Eco-Cup recovery, L 135 mm	5 ea		2020iD/iS 3030D/S
PY1-ES10F	Eco-Stick SF	For Single-shot Eco-Cups, L 30 mm , deactivated stainless steel	50 ea		2020iD/iS 3030D/S
PY1-ES20F	Eco-Stick DF	For Double-shot Eco-Cups, L 80 mm , deactivated stainless steel	50 ea		2020iD 3030D

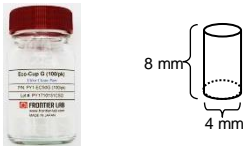
4. Sampling tool

4.1 Sample Cups

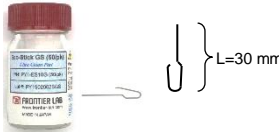

Eco-Cup G series (Glass)

P/N (part number)	Part name	Specification	Qty	Part	part
AS1-7814	AS Teflon Sheet G	Teflon sheet for cup chute of Auto-Shot Sampler(3ea), spare fixing screw (4ea), Attach when glass Eco-Cup is used with Auto-Shot Sampler (stainless steel Eco-Cups can also be used with Teflon sheet)	1 set		2020iD/iS 3030D/S
PY1-EC50G	Eco-Cup G	Non quartz coated, maximum use temp. 450°C 4 mm o.d. x H 8 mm , thickness 5 mm , 50 μL	100 ea		2020iD/iS 3030D/S
PY1-EC50GQ	Eco-Cup GQ	Glass coated with bonded quartz layer, maximum use temp. 600°C, 4 mm o.d. x H 8 mm , thickness 5 mm , 50 μL	30 ea		2020iD/iS 3030D/S
PY1-EC50GP-01	Polymer Coated Cup G	PVC coated glass cup, maximum use temp. 450°C, 50μL	10ea		2020iD/iS 3030D/S
PY1-EC50GP-05	Polymer Coated Cup G 5 sets	PVC coated glass cup, maximum use temp. 450°C, 50μL,	50ea		2020iD/iS 3030D/S
PY1-EP55GF	Eco-Pickup GF	For glass Eco-Cup recovery, L 135 mm	5 ea		2020iD/iS 3030D/S
PY1-ES10G	Eco-Stick GS	For glass Eco-Cups, L 30 mm, for Single-Shot	50 ea		2020iD/iS 3030D/S
PY1-ES20G	Eco-Stick GD	For glass Eco-Cups, L 80 mm, for Double-Shot	50 ea		2020iD 3030D

4. Sampling tool

4.1 Sample Cups

Common parts









P/N (part number)	Part name	Specification	Qty	Part
PY1-EH10AL	Eco-Stand AL	Eco-Cup stand for 1 cup, for all Eco-Cups, made of aluminum	5 ea	
PY1-3711	Eco-Cup Stand 10	For Eco-Cup LF and Eco-Cup G/GQ, for 10cups	1 ea	

4. Sampling tool

4.1 Sample Cups

Selection of the sample cups

2022/07/28



Product name	Product number (Quantity)	Material	Volume	Max. temp.	Compatibility with AS-1020E	Appearance	Description
Eco-Cup LF	PY1-EC80F (100 ea)	Stainless steel (Deactivated*1)	80 µL	1,050°C	Yes		<ul style="list-style-type: none"> All application*2 Optimum pyrolysis temperature is 30°C lower than Eco-cup SF for most polymeric materials due to large surface area. This is useful for samples with relatively large volumes. 100 ea x 4 bottles/set (P/N: PY1-EC80F-V4) is also available.
Eco-Cup SF	PY1-EC50F (100 ea)	Stainless steel (Deactivated*1)	50 µL	1,050°C	No		<ul style="list-style-type: none"> All application*2 This cup provides slightly better pyrogram reproducibility in flash pyrolysis-GC mode than Eco-cup LF.
RoHS-Cup LN	PY1-EC80N (100 ea)	Stainless steel (Non-Deactivated)	80 µL	700°C	Yes		<ul style="list-style-type: none"> For phthalates analysis only. Single use, disposable sample cup. 100 ea x 5 bottles/set (P/N: PY1-EC80N-V5), 100 ea x 10 bottles/set (P/N: PY1-EC80N-V10) are also available.
Eco-Cup G	PY1-EC50G (100 ea)	Pyrex glass (Glass surface)	50 µL	450°C	Yes*3		<ul style="list-style-type: none"> Disposable cup for Frontier-lab's pyrolyzer. The cups are made of clear glass, the sample position, sample color change, residues, and contamination can easily be observed. For thermal desorption and reactive pyrolysis. Maximum temperature is 450°C.
Eco-Cup GQ	PY1-EC50GQ (30 ea)	Pyrex glass (Quartz surface)	50 µL	600°C	Yes*3		<ul style="list-style-type: none"> Disposable cups for Frontier-lab's pyrolyzer. Glass coated with a bonded quartz layer. Maximum temperature is 600°C. For thermal desorption, reactive pyrolysis and pyrolysis
Eco-Cup LHF (Flow Through)	PY1-EC80HF (20 ea)	Stainless steel (Deactivated*1)	80 µL	1,050°C	No		<ul style="list-style-type: none"> This cup provides better peak shape resolution of volatile compounds (C3-10) than regular cups. And it prevents secondary reactions under a low carrier gas flow, e.g. 10 mL/min.
Eco-Cup SHF (Flow Through)	PY1-EC50HF (20 ea)	Stainless steel (Deactivated*1)	50 µL	1,050°C	No		<ul style="list-style-type: none"> This cup provides better peak shape resolution of volatile compounds (C3-10) than regular cups. And it prevents secondary reactions under a low carrier gas flow, e.g. 10 mL/min.
Side Hole Eco-Cup UV	PY1-EC80UV (20 ea)	Stainless steel (Deactivated*1)	80 µL	1,050°C	Yes		<ul style="list-style-type: none"> Used for analysis with Micro-UV Irradiator (UV/Py-GC/MS).

*1 The entire surface has been deactivated using the same proprietary technology used for Ultra Alloy® columns. The thickness is 0.1 mm.

*2 Except analysis with Micro-UV Irradiator (UV/Py-GC/MS). Please use the Side Hole Eco-Cup UV (P/N: PY1-EC80UV) when use UV-1047Xe.

*3 Use the sample cup recovery chute equipped with Teflon sheet.

Selecting between RoHS Cup LN and Eco-Cup LF

Sample cup	Product number	Analytical target		Description	Appearance
		Phthalate	Polymer/additive		
Eco-Cup LF	PY1-EC80F	○	○	<ul style="list-style-type: none"> Deactivated Can be reused Disposable use recommended for analysis of brominated flame retardants 100 ea x 4 bottles/set (P/N: PY1-EC80F-V4) is also available. 	 White label
RoHS-Cup LN	PY1-EC80N	○	×	<ul style="list-style-type: none"> No deactivation Disposable use Recommended for phthalates analysis 100 ea x 5 bottles/set (P/N: PY1-EC80N-V5), 100 ea x 10 bottles/set (P/N: PY1-EC80N-V10) are also available. 	 Orange label

4. Sampling tool

4.1 Sample Cups

Selection of the sample sticks

2022/07/28

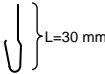
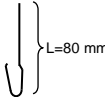
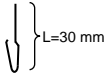
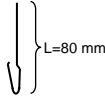
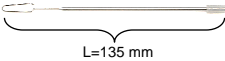
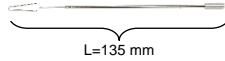
Product name	Product number (Quantity)	Material	Max. temp.	Appearance	Description
Eco-Stick SF	PY1-ES10F (50 ea)	Stainless steel (Deactivated*1)	1,050°C	 L=30 mm	<ul style="list-style-type: none"> For stainless steel Eco-Cups*1. Used for manual Single-Shot analysis, EGA analysis or Heart-Cut EGA analysis.
Eco-Stick DF	PY1-ES20F (50 ea)	Stainless steel (Deactivated*1)	1,050°C	 L=80 mm	<ul style="list-style-type: none"> For stainless steel Eco-Cups*1. Used for manual Double-Shot analysis.
Eco-Stick GS	PY1-ES10G (50 ea)	Stainless steel (Deactivated*1)	600°C	 L=30 mm	<ul style="list-style-type: none"> For glass Eco-Cups. Used for Single-Shot analysis, EGA analysis or Heart-Cut EGA analysis
Eco-Stick GD	PY1-ES20G (50 ea)	Stainless steel (Deactivated*1)	600°C	 L=80 mm	<ul style="list-style-type: none"> For glass Eco-Cups. Used for Double-Shot analysis.
Eco-Pickup F	PY1-EP55F (5 ea)	Stainless steel	1,050°C	 L=135 mm	<ul style="list-style-type: none"> For stainless steel Eco-Cup recovery
Eco-Pickup GF	PY1-EP55GF (5 ea)	Stainless steel	600°C	 L=135 mm	<ul style="list-style-type: none"> For glass Eco-Cup recovery

*1 The entire surface has been deactivated using the same proprietary technology used for Ultra Alloy® columns.



4. Sampling tool

4.2 Standard sample

P/N (part number)	Part name	specification	Qty	Part
PY1-4908	Polystyrene sample	For Pyrolyzer Performance Evaluation, Polystyrene 2.5 mg film, Me-stearate 5 w% in 2mL glass bottle	1 ea	

4.3 Magic Chemisorber

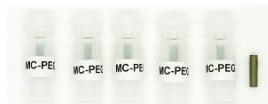
Magic Chemisorber PEG

P/N (part number)	Part name	Specification	Qty	Part
PY1-MC04P	Magic Chemisorber PEG-L	Includes Magic Chemisorber PEG-L	5 ea	
PY1-MC04P-K	Magic Chemisorber PEG-L Kit	Includes Magic Chemisorber PEG-L (5 ea) and Eco-Stick GD (5 ea)	1 set	
PY1-MC04PS	Magic Chemisorber PEG-S	Magic Chemisorber PEG-S	5 ea	
PY1-MC04PS-K	Magic Chemisorber PEG-S Kit	Magic Chemisorber PEG-S (5ea), Eco-stick DF (5ea), and Flow through Eco-cup LHF (5ea)	1 set	
PY1-MC04PSL-K	Magic Chemisorber PEG-SL Kit	Magic Chemisorber PEG-S (2ea) and PEG-L (2ea)	1 set	

4. Sampling tool





4.3 Magic Chemisorber

Magic Chemisorber PDMS

P/N (part number)	Part name	Specification	Qty	Part
PY1-MC01L	Magic Chemisorber L500	100% dimethylpolysiloxane, film thickness 500 µm, L 34.5 mm, use with PY1-MCP01	5 ea	
PY1-MC01L-K	Magic Chemisorber L500 Kit	Includes Magic Chemisorber L500 (3 ea), Eco-Stick DF (5 ea) and MC holder L (2 ea)	1 set	
PY1-MC01S	Magic Chemisorber S500	100% dimethylpolysiloxane, film thickness 500 µm, L 6 mm, use with PY1-EC80HF or PY1-EC80F	10 ea	
PY1-MC01S-K	Magic Chemisorber S500 Kit	Includes Magic Chemisorber S500(3 ea), Eco-Stick DF (5 ea) and MC holder S (Flow through Eco-Cup LHF, 5 ea)	1 set	
PY1-MC01SL-K	Magic Chemisorber SL Kit	Includes Magic Chemisorber L500 (2 ea), Magic Chemisorber L100 (2 ea) and Magic Chemisorber S500 (2 ea)	1 set	
PY1-MCP01	MC holder L	Protective tube for Magic Chemisorber L	3 ea	
PY1-MC02L	Magic Chemisorber L100	100% dimethylpolysiloxane, film thickness 100 µm, L 30mm	5 ea	
PY1-MC02L-K	Magic Chemisorber L100 Kit	Includes Magic Chemisorber L100 (3ea), Eco-stick DF (5ea) and MC holder L (2ea)	1 set	

4. Sampling tool

4.4 Micro Sample Collector

P/N (part number)	Part name	Specification	Qty	Part
PY1-1070	Micro Sample Collector Kit	Micro sample collector (5 ea), Micro coil S (20 ea), Plunger stopper (5 ea)	1 set	
PY1-1071	Micro Sample Collector	Micro sample collector (5 ea), Plunger stopper (5 ea)	1 set	
PY1-1073	Plunger Stopper	Plunger stopper	10 ea	
PY1-1075	Micro Coil S	Micro Coil S 100 ea	100 ea	

4. Sampling tool

4.5 Sampling Tools

Micro-puncher

A set of three Micro-punchers (same inner diameter) and one Cutting Mat L.

P/N (part number)	Part name	Specification	Qty	Part
FMP-0.50S	Micro-puncher 050S	0.50 mm i.d., 3 punchers, 1 Cutting Mat L ,White	1 set	 <p>A variety of Micro-punchers and Cutting Mat L</p>
FMP-0.75S	Micro-puncher 075S	0.75 mm i.d., 3 punchers, 1 Cutting Mat L , White	1 set	
FMP-1.25S	Micro-puncher 125S	1.25 mm i.d., 3 punchers, 1 Cutting Mat L ,White	1 set	
FMP-2.00S	Micro-puncher 200S	2.00 mm i.d., 3 punchers, 1 Cutting Mat L , White	1 set	
FMP-3.00S	Micro-puncher 300S	3.00 mm i.d., 3 punchers, 1 Cutting Mat L, White	1 set	
FMP-4.00S	Micro-puncher 400S	4.00 mm i.d., 3 punchers, 1 Cutting Mat L, White	1 set	
FMP-5.00S	Micro-puncher 500S	5.00mm i.d., 3 punchers, 1 Cutting Mat L, White	1 set	



A set of ten Micro-punchers (same inner diameter). The Cutting Mat L is not included.

P/N (part number)	Part name	Specification	Qty	Part
FMP-0.50D	Micro-puncher 050D	0.50 mm i.d., White	10 ea	 <p>A variety of Micro-punchers and Cutting Mat L</p> <p>※Cutting Mat L is not included in this products.</p>
FMP-0.75D	Micro-puncher 075D	0.75 mm i.d., White	10 ea	
FMP-1.25D	Micro-puncher 125D	1.25 mm i.d., White	10 ea	
FMP-2.00D	Micro-puncher 200D	2.00 mm i.d., White	10 ea	
FMP-3.00D	Micro-puncher 300D	3.00 mm i.d., White	10 ea	
FMP-4.00D	Micro-puncher 400D	4.00 mm i.d., White	10 ea	
FMP-5.00D	Micro-puncher 500D	5.00mm i.d., White	10 ea	

4. Sampling tool

4.5 Sampling Tools

Micro-puncher

P/N (part number)	Part name	specification	Qty	Part
FMP-03KIT	Micro-puncher 03 Kit	3 pcs each of 0.75/ 1.25/ 2.0 (mm i.d.) punchers and 2 sheets of Cutting Mat L	1 set	
FMP-04KIT	Micro-puncher 04 Kit	3 pcs each of 3.0 /4.0 /5.0 (mm i.d.) punchers and 2 sheets of Cutting Mat L	1 set	
P/N (part number)	Part name	Specification	Qty	Part
FCM-6577	Cutting Mat L	L 150 mm x W 220 mm Light green	5 ea	

4. Sampling tool

4.5 Sampling Tools

Sampling Tool Kit 01



P/N: PY1-K101
1 set

Contents of PY1-K101		Qty
1)	Cutting Mat L	2 ea
2)	Micro-puncher 125D	5 ea
3)	Tweezers	3 ea
4)	Cutter Knife	2 ea
5)	Scissors	1 ea
6)	Precision Scissors	1 ea

※ Use the following part numbers when ordering the parts individually. The quantities of each parts may differ from the Sampling Tool Kit 01. The quantities of the parts contained in the Sampling Tool Kit 01 are shown in the list above.

No.	P/N (part number)	Part name	Specification	Qty	Part
1	FCM-6577 *1	Cutting Mat L	L 150 mm x W 220 mm Light green	5 ea	
2	FMP-1.25D *1	Micro-puncher 125D	Micro-puncher 1.25mm i.d., White	10 ea	
3	PY1-7141	Tweezers	L 125 mm	1 ea	
4	PY1-7151	Cutter Knife	Incl. spare blades (25 pcs)	1 ea	
5	PY1-7161	Scissors	L 176 mm , Blades 65 mm	1 ea	
6	PY1-7162	Precision Scissors	L 90 mm , Blades 16 mm	1 ea	

*1 : A set of Micro-puncher 125 (3 ea) and Cutting Mat L (1 ea) is available.
(Product name: Micro-puncher 125S, P/N: FMP-1.25S)

Micro-punchers have 7 kinds of inner diameter (0.5/ 0.75/ 1.25/ 2.0/ 3.0/ 4.0/ 5.0 mm).
Refer to the catalog of Micro-puncher from Frontier-lab's website for details.

4. Sampling tool

4.5 Sampling Tools

Sampling Tool Kit 02



P/N: PY1-K102

1set

Contents of PY1-K102		Qty
1)	Cutting Mat L	1 ea
2)	Micro-puncher 050D	3 ea
3)	Micro-puncher 075D	3 ea
4)	Micro-puncher 125D	3 ea
5)	Micro Sample Collector	1 ea
6)	Eco-Cup Stand 10	1 ea
7)	Tweezers	2 ea
8)	Blunt Tip Tweezers	1 ea
9)	Sampling Needle	3 ea
10)	Double Head Spatula	1 ea
11)	Cutter Knife	1 ea
12)	Scissors	1 ea
13)	Precision Scissors	1 ea
14)	Eco-Stand AL	2 ea
15)	File for Ultra ALLOY Capillary Tube	1 ea

※ Use the following part numbers when ordering the parts individually. The quantities of each parts may differ from the Sampling Tool Kit 02. The quantities of the parts contained in the Sampling Tool Kit 02 are shown in the list above.









No.	P/N (part number)	Part name	Specification	Qty	Part
1	FCM-6577 *1	Cutting Mat L	L 150 mm x W 220 mm Light green	5 ea	
2	FMP-0.50D *1	Micro-puncher 050D	Micro-puncher 0.5mm i.d., White	10 ea	
3	FMP-0.75D *1	Micro-puncher 075D	Micro-puncher 0.75mm i.d., White	10 ea	
4	FMP-1.25D *1	Micro-puncher 125D	Micro-puncher 1.25mm i.d., White	10 ea	
5	PY1-1070 *2	Micro Sample Collector Kit	Incl. Micro Coil S (20 ea)	5 ea	
6	PY1-3711	Eco-Cup Stand 10	For Eco-Cup LF and Eco-Cup G/GQ, for 10cups	1 ea	

4. Sampling tool

4.5 Sampling Tools

Sampling Tool Kit 02 (Cont.)

※ Use the following part numbers when ordering the parts individually. The quantities of each parts may differ from the Sampling Tool Kit 02. The quantities of the parts contained in the Sampling Tool Kit 02 are shown in the list above.

No.	P/N (part number)	Part name	Specification	Qty	Part
7	PY1-7141	Tweezers	L 125 mm	1 ea	
8	PY1-7142	Blunt Tip Tweezers	L 125 mm	1 ea	
9	PY1-7145	Sampling Needle	For viscous liquids	5 ea	
10	PY1-7147	Double Head Spatula	Gathers powder samples	1 ea	
11	PY1-7151	Cutter Knife	Incl. spare blades (25 pcs)	1 ea	
12	PY1-7161	Scissors	L 176 mm , Blades 65 mm	1 ea	
13	PY1-7162	Precision Scissors	L 90 mm , Blades 16 mm	3 ea	
14	PY1-EH10AL	Eco-Stand AL	Eco-Cup stand for 1 cup, for all Eco-Cups, made of aluminum	5 ea	
15	UAP-7001	File for Ultra ALLOY Capillary Tube	File for cutting capillary tubes	1 ea	

*1 A set of Micro-puncher (3 ea) and Cutting Mat L (1 ea) is available.

Product name : Micro-puncher 050S, P/N : FMP-0.50S

Product name : Micro-puncher 075S, P/N : FMP-0.75S

Product name : Micro-puncher 125S, P/N : FMP-1.25S

Micro-punchers have 7 kinds of inner diameter (0.5/ 0.75/ 1.25/ 2.0/ 3.0/ 4.0/ 5.0 mm).

Refer to the catalog of Micro-punchers from Frontier-lab's website for details.

*2 Micro Sample Collector Kit (P/N: PY1-1070) comes with Micro Coil S (20 ea).











Micro Sample Collector and Micro Coil S are available individually.

Product name : Micro Sample Collector (5 ea), P/N : PY1-1071

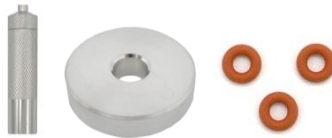
Product name : Micro Coil S (20 ea x 5), P/N : PY1-1075

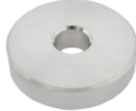



5. Sampler

5.1 On-line Micro Reaction Sampler (PY1-1050)

P/N (part number)	Part name	Specification	Qty	Part
PY1-3321	SUS Pyrolysis Tube 3030	Deactivated stainless steel	1 ea	
PY1-5113	Glass Capsule B	L 40 mm	20 ea	
PY1-5114	Glass Capsule B 120	L 120 mm	20 ea	
PY1-5311	Reaction Chamber		1 ea	
PY1-5315	Glass Capsule Sealing Assembly	Glass Capsule Holder A1 (1 ea) Glass Capsule Holder B1 (1 ea) Glass Capsule Holder Base A (1 ea) O-ring S3 (red, 3 ea)	1 set	
PY1-5316	Glass Capsule Holder A1	Top part of capsule holder	1 ea	
PY1-5317	Glass Capsule Holder B1	Bottom part of capsule holder	1 ea	
PY1-5318	Glass Capsule Holder Base A	Aluminum base, for capsule holder stands on	1 ea	
PY1-5319	O-ring S3	Red	20 ea	
UV1-3802	UV Sampler Stand	Stand for sampler	1 ea	
UV1-7701	O-ring S4	Fluorine rubber, black	10 ea	

5. Sampler

5.2 Micro Thermal Desorption Sampler (PY1-1060)

P/N (part number)	Part name	Specification	Qty	Part
PY1-5210	TD tube packed with Tenax	For micro therm desorption (PY1-1060). TD tube packed with Tenax	3 ea	
PY1-5220	TD tube	For micro thermal desorption sampler (PY1-1060), cleaned blank glass tube	5 ea	
UV1-3802	UV Sampler Stand	Stand for sampler	1 ea	
UV1-7701	O-ring S4	Fluorine rubber, black	10 ea	

6. Selective Sampler (SS-2010E/1010E)

Connection parts for GC inlet

Depending on the combination of your GC and pyrolyzer, different part is used.

Please make sure to select parts compatible with your GC.

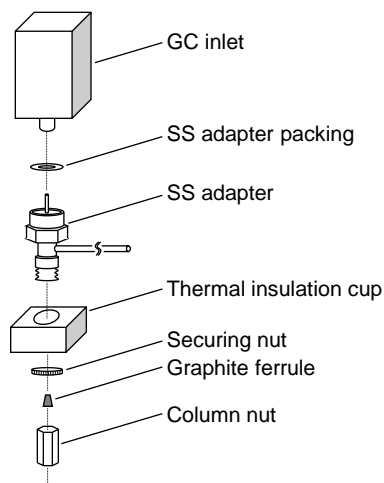

Connection parts underneath GC inlet

GC	SS Adapter Packing	SS Adapter	Thermal Insulation Cup	Securing nut	Graphite ferrule	Column nut
Agilent 7890/6890	SS1-1011	SS1-1001	SS1-1012	SS1-1013	PY1-7971	MS604234 ¹⁾
Shimadzu GC-2030/2010/17A	SS1-2011	SS1-2001	SS1-2012	Not necessary ²⁾	SS1-7215	SS1-7201 ³⁾
Thermo TRACE 1600/1610/1300/1310 GC	SS1-1011	SS1-3101	Not necessary ⁴⁾	Not necessary	PY1-7971	MS604234
Thermo TRACE GC	*	SS1-3001	SS1-3012	SS1-1013	PY1-7971	SS1-7301
Thermo Focus GC	*	SS1-3001	SS1-3022	SS1-1013	PY1-7971	SS1-7301

¹⁾ Agilent column nut (Agilent P/N: 5181-8830) can be used

²⁾ Standard screws for GC are used



³⁾ Shimadzu column nut (Shimadzu P/N: 221-32705) can be used

⁴⁾ Use the thermal insulator (P/N: MJ1-1518)





* Order Thermo Fisher's genuine part (Thermo Fisher P/N: 29033629)

6. Selective Sampler (SS-2010E/1010E)





SS Adapter Packing

P/N (part number)	Part name	Specification	Qty	Part
SS1-1011	SS Adapter Packing for Agilent, Thermo 1600/1610/1300/1310 GC	For SS adapter (SS1-1001 and SS1-3101)	10 ea	
SS1-2011	SS Adapter Packing for Shimadzu	For SS Adapter (SS1-2001)	10 ea	

SS Adapter

P/N (part number)	Part name	Specification	Qty	Part
SS1-1001	SS Adapter for Agilent	For Agilent 7890/6890	1 set	
SS1-2001	SS Adapter for Shimadzu	For Shimadzu GC-17A/2010/2030, includes purge line capillary tube (1.75 m , 0.25 mm i.d.)	1 set	
SS1-3001	SS Adapter for TRACE GC Ultra/FOCUS GC	For TRACE GC Ultra/FOCUS GC, includes purge line capillary tube (1.75 m , 0.25 mm i.d.)	1 set	
SS1-3101	SS Adapter for TRACE 1600/1610/1300/1310 GC	SS adapter for Thermo TRACE 1600/1610/1300/1310 GC, includes purge line capillary tube (1.75 m , 0.25 mm i.d.)	1 set	

Thermal Insulation Cup



P/N (part number)	Part name	Specification	Qty	Part
SS1-1012	Thermal Insulation Cup for Agilent	For SS adapter (SS1-1001)	1 ea	
SS1-2012	Thermal Insulation Cup for Shimadzu	For SS adapter (SS1-2001), includes 2 securing screws	1 ea	
SS1-3012	Thermal Insulation Cup for TRACE GC Ultra	For Thermo TRACE GC Ultra	1 ea	
SS1-3022	Thermal Insulation Cup for FOCUS GC	For Thermo FOCUS GC	1 ea	

6. Selective Sampler (SS-2010E/1010E)



Thermal Insulation Cup

P/N (part number)	Part name	Specification	Qty	Part
SS1-1013	Thermal Insulation Cup Securing Nut (for Agilent&Thermo GCs)	Fixing nut of thermal insulation cup for SS adapter (SS1-1001 and SS1-3001)	1 ea	

Graphite ferrule

P/N (part number)	Part name	Specification	Qty	Part
PY1-7971	Graphite Vespel Ferrule 05	0.5 mm hole i.d., for Ultra ALLOY Capillary column and EGA tube	10 ea	
SS1-7215	Graphite Ferrule 0.5	Graphite ferrule for Shimadzu GC	10 ea	

Column nut

P/N (part number)	Part name	Specification	Qty	Part
MS604234	Column Nut		1 ea	
SS1-7201	Column Nut	For Shimadzu GC	1 ea	
SS1-7301	Column Nut T for TRACE GC Ultra/FOCUS GC	For TRACE GC Ultra/FOCUS GC, for SS adapter (SS1-3001)	1 ea	

6. Selective Sampler (SS-2010E/1010E)

Other parts

P/N (part number)	Part name	Specification	Qty	Part
PY1-3337	Glass Insert	Deactivated glass insert	1 ea	
SS1-4210	Purge Line Kit		1 set	
SS1-4211	Purge Line Capillary Tube	0.25 mm i.d., 1.75 m	1 ea	
SS1-4300	Plumbing Kit	includes 1 ea of copper Tube 3 m, 1/8 tee union and 1/8 cap nut	1 set	
SS1-7101	Double Head Wrench	Wrench 12-14 mm	1 ea	
SS1-7355	Inlet/Outlet Septum for capillary tube	Inlet/outlet septum (rubber seal with hole) for SS connecting tubes	10 ea	

7. Multi-Functional Splitless Sampler (MFS-2015E)









Multi-Functional Splitless Sampler related parts

MFS Splitter kit

P/N: MF1-1000





Contents of PY-K303D		Qty
1)	MFS Tube	1 set
2)	MFS Splitter	1 ea
3)	VF Metal Ferrule D	10 ea
4)	VF Nut C	1 ea
5)	Inlet/Outlet Septum	3 ea
6)	Double Head Wrench (6/8 mm)	2 ea
7)	Inlet/Outlet Septum for capillary tube	3 ea
8)	Ceramic Cutter	1 ea
9)	UA Precolumn 50 (with VF Nut C and VF Metal Ferrule D, 1ea)	1 ea

※ Use the following part numbers when ordering the parts individually. The quantities of each parts may differ from the Consumable Parts Set. The quantities of the parts contained in the Consumable Parts Set are shown in the list above.

No.	P/N (part number)	Part name	Specification	Qty	Part
1	MF1-2001	MFS Tube	includes 1 ea of 1/8 nut, back ferrule and silicone rubber	1 set	
2	MF1-2005	MFS Splitter	-	1 ea	
3	MS402167	VF Metal Ferrule D	-	20 ea	
4	MS402287	VF Nut C	For the interface between VF Holder N and VF tube	3 ea	
5	PY1-2028	Inlet/Outlet Septum	For connecting tubes, with hole	20 ea	
6	Rx1-3532	Double Head Wrench (6/8 mm)	6-8 mm	1 ea	
7	SS1-7355	Inlet/Outlet Septum for capillary tube	Inlet/outlet septum (rubber seal with hole) for SS connecting tubes	10 ea	
8	UAP-7002	Ceramic Cutter	W 40 x H 25 mm, thickness 1 mm	5 ea	
9	UAMP-2M-1.0F	UA Precolumn 50	-	2 ea	

7. Multi-Functional Splitless Sampler (MFS-2015E)

Other parts

P/N (part number)	Part name	Specification	Qty	Part
MF1-1010	MFS Valve control cable 3030	Valve control cable for MFS-2015E, Compatible with EGA/PY-3030D	1 ea	
MJ1-1518	Thermal insulator for Thermo TRACE 1600/1610/1300/1310GC	Thermal insulator Thermo TRACE 1600/1610/1300/1310GC	1 set	
PY1-7601	Valve cable for 3030	Valve cable for EGA/PY-3030D, compatible with MFS-2015E	1 ea	
SS1-4300	Plumbing Kit	includes 1 ea of copper Tube 3 m, 1/8 tee union and 1/8 cap nut	1 set	

7. Multi-Functional Splitless Sampler (MFS-2015E)

Other parts

Power Cable (Pyrolyzer and Accessory)

Depending on the country / region, different power cable is used.

Please make sure to select a part compatible with your country / region.

P/N (part number)	Part name	Specification	Qty	Part
PY1-7001	AC Power Cable 100V for UL standard	AC Power Cable 100-120V for UL standard, includes noise filter 09 (1 ea)	1 ea	
PY1-7022	AC Power Cable 200VF for VDE standard	AC Power Cable 200-240V for VDE standard, includes noise filter 13 (1 ea)	1 ea	
PY1-7025	(For China only) AC Power Cable 200VF for CCC standard	(For China only) AC Power Cable 200-240V for CCC standard, include noise filter 13 (1ea)	1 ea	
PY1-7032	(For Korea only) AC Power Cable 200VF for KC standard	(For Korea only) AC Power Cable 200-240V, 10A/AC250V, 2 m, for KC standard, includes noise filter 13 (1 ea)	1 ea	
PY1-7035	(For UK only) AC Power Cable 200VF for BS standard	(For UK only) AC Power Cable 200-240V for BS standard, include noise filter 13 (1ea)	1 ea	

8. MicroJet Cryo-Trap (MJT-2030E/1035E)

MJT parts in GC oven







P/N (part number)	Part name	Specification	Qty	Part
MJ1-1111	Micro Jet Tube	MicroJet Tube, quartz	1 ea	
MJ1-1121	LN2 Saver	Two in 1 set	1 set	
MJ1-1304	Thermal Exchange Coil 10L	Thermal exchange coil for 10 liters container	1 ea	
MJ1-1305	Thermal Exchange Coil 2L	Thermal exchange coil for 2 liters container	1 ea	
MJ1-1306	Thermal Exchange Coil 30L	For use with a 30L liquid nitrogen container	1 ea	
MJ1-1500	Liquid Nitrogen Container Kit	Bench top Liquid Nitrogen Container Kit, includes, each 1 pcs of Container cap 2L, Thermal exchange coil 2L, Liquid N2 container 2L, Stand base, Stand pole, Clamp and Indicator	1 set	
MJ1-1511	Liquid N2 Container 2L		1 ea	
MJ1-1512*	Container Cap 2L <small>*Discontinue on Sep.30, 2024.</small>	For liquid N2 container 2L (MJ1-1511)	1 ea	
MJ1-1513	Stand Base		1 ea	
MJ1-1514	Stand Pole		1 ea	

8. MicroJet Cryo-Trap (MJT-2030E/1035E)

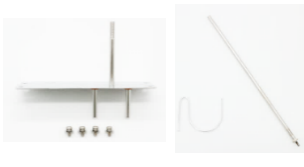
P/N (part number)	Part name	Specification	Qty	Part
MJ1-1515	Clamp	Clamp for holding liquid nitrogen feed tube	1 ea	
MJ1-1517	Indicator	Liquid nitrogen fluid level indicator for 2 liters container	1 ea	
MJ1-1522*	Container Cap 30L <small>*Discontinue on Sep.30, 2024. (Replacement P/N: MJ1-1531)</small>	For 30L container	1 ea	
MJ1-1531	Liquid Nitrogen Container Cap	Liquid nitrogen fluid level indicator for both 2 liters and 30 liters container	1 ea	
MJ1-1600	Thermal Exchange Coil Set for 30L Container	Includes each 1 of Container Cap and Thermal Exchange Coil 30L	1 set	
MJ1-3101	MicroJet Tube Union Set	Includes each 1 pcs of hexagon cap nut and fixing nut	1 set	
MJ1-7941	Graphite Ferrule	Graphite ferrule for MicroJet tube	5 ea	

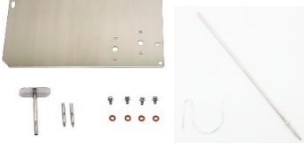
8. MicroJet Cryo-Trap (MJT-2030E/1035E)







Installation Kit

P/N (part number)	Part name	Specification	Qty	Part
MJ1-K201	MJT-2030E/1030E/Ex Installation Kit for Shimadzu GC-17A/2010/2030	Includes support plate (MJ1-1204) and tube hanger (MJ1-3501)	1 set	
MJ1-K380	MJT-2030E/1030E/Ex Installation Kit for Varian CP3800GC	Includes support plate (MJ1-1208) and tube hanger(MJ1-3501)	1 set	
MJ1-K580	MJT-2030E/1030E/Ex Installation Kit for HP5890	Includes support plate (MJ1-1202) and tube hanger (MJ1-3501)	1 set	
MJ1-K680	MJT-2030E/1030E/Ex Installation Kit for Agilent7890/6890	Includes support plate (MJ1-1212) and tube hanger(MJ1-3502)	1 set	
MJ1-K801	MJT-2030E/1030E/Ex Installation Kit for PerkinElmer Clarus GC	Includes support plate (MJ1-1209) and tube hanger (MJ1-3501)	1 set	
MJ1-K901	MJT-2030E/1030E/Ex Installation Kit for Thermo TRACE GC Ultra	Includes support plate (MJ1-1207) and tube hanger (MJ1-3501)	1 set	
MJ1-K903	MJT-2030E/1030E/Ex Installation Kit for Thermo TRACE 1600/1610/1300/1310 GC	Includes support plate (MJ1-1218), Thermal insulator (MJ1-1518)	1 set	

8. MicroJet Cryo-Trap (MJT-2030E/1035E)



Liquid Nitrogen Feed Tube Securing Plate for Major GCs

The shape and size of the liquid nitrogen feed tube securing plates vary depending on your GC model. Choose the right one for your GC from the table below.

















P/N (part number)	Part name	Specification	Qty	Part
MJ1-1202	Securing Plate	For HP 5890	1 set	
MJ1-1204		For Shimadzu GC-2030 / 2010 / 17A	1 set	
MJ1-1207		For Thermo Fisher TRACE GC Ultra	1 set	
MJ1-1208		For Varian CP3800 GC	1 set	
MJ1-1209		For PerkinElmer Clarus GC	1 set	
MJ1-1212		For Agilent 8890/7890/6890GC	1 set	
MJ1-1211		For Agilent 8890/7890GC SP-1 and Sideways	1 set	
MJ1-1218		For Thermo Fisher TRACE 1600/1610/1300/1310 GC	1 set	

8. MicroJet Cryo-Trap (MJT-2030E/1035E)

Tube Hanger













P/N (part number)	Part name	Specification	Qty	Part
MJ1-3501	Tube Hanger for HP5890, Shimadzu GC-17A/2010/2030, TRACE GC, CP3800	Liquid nitrogen feed tube hanger (for HP5890, Shimadzu GC-17A/2010/2030, TRACE GC and Varian CP3800)	1 set	
MJ1-3502	Tube Hanger for Agilent6890	Liquid nitrogen feed tube hanger (for Agilent6890)	1 set	

Installation Kit (MJT-1035E)

P/N (part number)	Part name	Specification	Qty	Part
MJ1-K211	MJT-1035E Installation Kit for Shimadzu GC-17A/2010/2030	Includes support plate(MJ1-1204), tube hanger(MJ1-3501), GC remote signal cable S (MJ1-4312), and Auto sampler connection cable G (MJ1-4301)	1 set	   
MJ1-K381	MJT-1035E Installation Kit (for Varian CP3800/450GC)	Includes support plate(MJ1-1208) , tube hanger(MJ1-3501), GC remote signal cable V (MJ1-4315), and Auto sampler connection cable G (MJ1-4301)	1 set	   
MJ1-K780	MJT-1035E Installation Kit (for Agilent7890/6890)	Includes support plate(MJ1-1212), tube hanger(MJ1-3502), GC remote signal cable A (MJ1-4311), and Auto sampler connection cable G (MJ1-4301)	1 set	   
MJ1-K781	MJT-1035E Installation Kit (for Agilent 8890/7890/6890 Sideways/SP-1 option)	Includes support plate(MJ1-1211) , tube hanger(MJ1-3502), GC remote signal cable A (MJ1-4311), and Auto sampler connection cable A (MJ1-4304)	1 set	   



8. MicroJet Cryo-Trap (MJT-2030E/1035E)

Installation Kit (MJT-1035E)



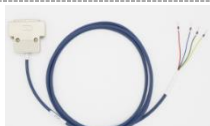

P/N (part number)	Part name	Specification	Qty	Part
MJ1-K811	MJT-1035E Installation Kit (for PerkinElmer Clarus GC)	Includes support plate(MJ1-1209) , tube hanger(MJ1-3501), GC remote signal cable P (MJ1-4313), and Auto sampler connection cable G (MJ1-4301)	1 set	   
MJ1-K911	MJT-1035E Installation Kit (for Thermo TRACE GC Ultra)	Includes support plate (MJ1-1207), tube hanger(MJ1-3501), GC remote signal cable T (MJ1-4314), and Auto sampler connection cable G (MJ1-4301)	1 set	   
MJ1-K913	MJT-1035E Installation Kit (for Thermo TRACE 1600/1610/1300/1310 GC)	Includes support plate (MJ1-1218), Thermal insulator (MJ1-1518), GC remote signal cable T (MJ1-4314), and Auto sampler connection cable G (MJ1-4301)	1 set	   

8. MicroJet Cryo-Trap (MJT-2030E/1035E)

GC Remote Signal Cable

P/N (part number)	Part name	Specification	Qty	Part
MJ1-4311	GC Remote Signal Cable A	MJT remote cable for Agilent 7890/6890	1 ea	
MJ1-4312	GC Remote Signal Cable S/P	MJT remote cable for Shimadzu 2030/2010GC/PerkinElmer Clarus GC	1 ea	
MJ1-4314	GC Remote Signal Cable T	MJT remote cable for Thermo Fishier TRACE GC	1 ea	
MJ1-4315	GC Remote Signal Cable V	MJT remote cable for Varian CP3800/GC450	1 ea	

Miscellaneous Parts

P/N (part number)	Part name	Specification	Qty	Part
MJ1-1313	Liquid Nitrogen Feed Tube N		1 set	
MJ1-4201	MJT Control Cable		1 ea	
MJ1-4202	MJT Signal Cable	MJT signal cable for connecting MJT-1030E/Ex, MJT-1035E with PY-3030 series	1 ea	
MJ1-4215	Short Plug B	For terminating temp. sensor input connector	1 ea	
MJ1-5501	MS (Molecular Sieve) Trap	With copper tube 1.2 m and 15µm filter	1 set	

9. Auto-Shot Sampler (AS-2020E/1020E)

AS-2020E Component Parts for Upper Section of Unit

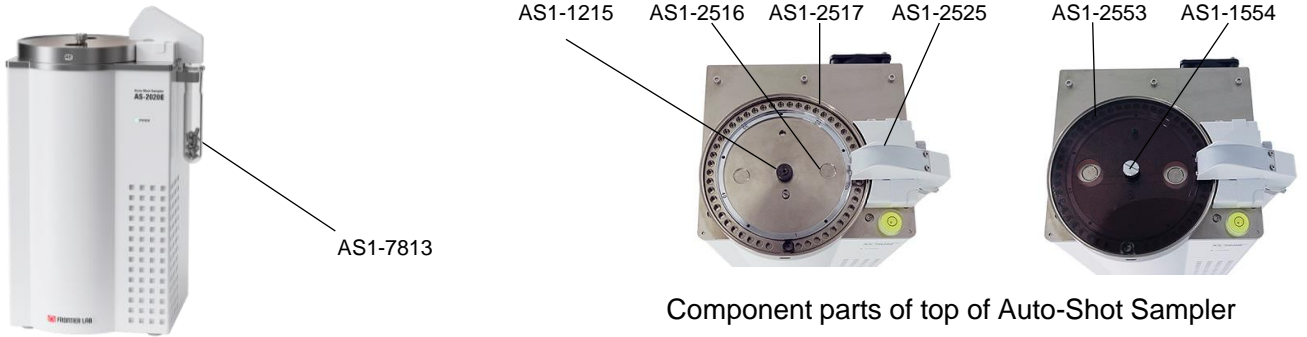

Component parts of top of Auto-Shot Sampler

P/N (part number)	Part name	Specification	Qty	Part
AS1-2551	Sample Cup Tray Set N20	Includes each 1 pcs of sample cup carousel N20, sample cup tray N20 and securing screw	1 set	
AS1-1215	Sample Cup Tray Securing Screw	For sample cup tray N/N20 and sample cup carousel N/N20	1 ea	
AS1-2516	Sample Cup Carousel N20	For loading sample cups	1 ea	
AS1-2517	Sample Cup Tray N20	Sample cup tray N20, shiny metallic surface	1 ea	
AS1-2525	Sample Cup Recovery Chute N20 (AS Teflon sheet)	Sample cup recovery chute equipped with AS Teflon sheet	1 ea	
AS1-2553	Sample Cup Tray Cover N20	Acrylic top cover of sample cup carousel	1 ea	
AS1-1554	Sample Cup Tray Cover Securing Screw	Securing screw for sample Cup Tray Cover	1 ea	
AS1-7813	Sample Cup Recovery Container		2 ea	
AS1-7814	AS Teflon Sheet G	Teflon sheet for cup chute(3 ea) and Spare fixing screw (4 ea)	1 set	

9. Auto-Shot Sampler (AS-2020E/1020E)

AS-1020E Component Parts for Upper Section of Unit



AS1-7813

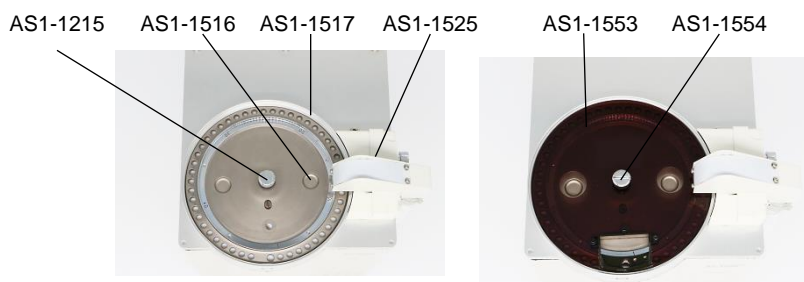







Component parts of top of Auto-Shot Sampler

P/N (part number)	Part name	Specification	Qty	Part
AS1-1551	Sample Cup Tray Set N	Includes each 1 pcs of sample cup carrousel N, sample cup tray N and securing screw	1 set	
AS1-1215	Sample Cup Tray Securing Screw	For sample cup tray N/N20 and sample cup carrousel N/N20	1 ea	
AS1-1516	Sample Cup Carrousel N	For loading sample cups	1 ea	
AS1-1517	Sample Cup Tray N	Sample cup tray N, shiny metallic surface	1 ea	
AS1-1525	Sample Cup Recovery Chute (AS Teflon sheet)	Sample cup recovery chute equipped with AS Teflon sheet	1 ea	
AS1-1553	Sample Cup Tray Cover	Acrylic top cover of sample cup carrousel	1 ea	
AS1-1554	Sample Cup Tray Cover Securing Screw	Securing screw for sample Cup Tray Cover	1 ea	
AS1-7813	Sample Cup Recovery Container		2 ea	
AS1-7814	AS Teflon Sheet G	Teflon sheet for cup chute(3 ea) and Spare fixing screw (4 ea)	1 set	

9. Auto-Shot Sampler (AS-2020E/1020E)

Installation Kit for Major GCs (AS-1020E)

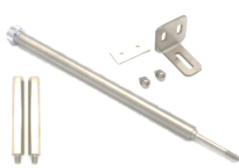



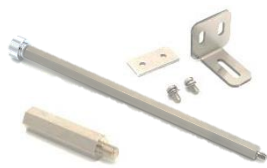

P/N (part number)	Part name	Specification	Qty	Part
AS1-K202	AS-1020E Installation Kit for Shimadzu GC- 2010/2030 detector position	Includes AS securing plate (1ea), AS fixing washer (1ea), AS fixing screw (1ea), and AS stand (80mm, 2ea). Installation plate (PY1-3854) is required.	1 set	
AS1-K203	AS-2020/1020E Installation Kit for Shimadzu GC-2010, 2010 Plus/2030, GC-17A *Common with AS-2020E.	Includes AS supporting plate for Pyrolyzers (1 ea), Supporting plate fixing screws (M4 x 20 mm, 2 ea), Spacer (10 mm, 2 ea), Mainframe fixing screw (1 ea), and Stand for Auto-Shot Sampler (40 mm hexagonal post, 1 ea)	1 set	
AS1-K380	AS-1020E Installation Kit for SCION GC	For Varian GC3800/Bruker SCION 430/436/450/456-GC, includes each 1 pcs of securing plate, washer and fixing screw. Stand base(PY1-1702) is required.	1 set	
AS1-K680	AS-1020E Installation Kit for Agilent 8890/7890/6890	Includes supporting rod with a fixing screw (1 set) and AS securing bracket (with screws, 1 ea)	1 set	
AS1-K780	AS-1020E Installation Kit 780	For Agilent 7890/7820, used for mounting AS-1020E on the back inlet. Includes AS support attachment (1 ea), support attachment2 (1 ea), support 2 fixing screw (1 ea) and M3x6 screws (2 ea)	1 set	
AS1-K786	AS-1020E Sideways Installation Kit K786 for Agilent 8890/7890	For PY-K7894, includes Sample cup recovery chute for sideways installation (AS1-1535)	1 set	
AS1-K902	AS-1020E Mounting Kit N for TRACE GC Ultra	Includes supporting rod with a fixing screw, nut and washers (1set), AS securing bracket (with screws, 1ea) and extension stand (80 mm, 2 ea)	1 set	

9. Auto-Shot Sampler (AS-2020E/1020E)

Installation Kit for Major GCs (AS-1020E)



P/N (part number)	Part name	Specification	Qty	Part
AS1-K904	AS-1020E Mounting Kit N for TRACE GC 1600/1610/1300/1310	Includes supporting rod with a screw (1 set), AS mounting plate with screws (1 set) and Extension stand (40 mm, 1 ea)	1 set	

Installation Kit for Major GCs (AS-2020E)





P/N (part number)	Part name	Specification	Qty	Part
AS1-K203	AS-2020/1020E Installation Kit for Shimadzu GC-2010, 2010 Plus/2030, GC-17A *Common with AS-1020E.	Includes AS supporting plate for Pyrolyzers (1 ea), Supporting plate fixing screws (M4 x 20 mm, 2 ea), Spacer (10 mm, 2 ea), Mainframe fixing screw (1 ea), and Stand for Auto-Shot Sampler (40 mm hexagonal post, 1 ea)	1 set	
AS1-K204	AS-2020E Installation Kit for Shimadzu GC-2010/2030 detector position	Includes AS securing plate N20 (1 ea), AS fixing washer (1 ea), AS fixing screw (1 ea), and AS stand (80 mm, 2 ea) Installation plate (PY1-3854) is required.	1 set	
AS1-K381	AS-2020E Installation Kit for SCION GC	For Varian GC3800/Bruker SCION 430/436/450/456-GC includes each 1 pcs of securing plate, washer, and fixing screw. Stand base (PY1-1702) is required.	1 set	
AS1-K681	AS-2020E Installation Kit for Agilent 8890/7890/6890	For Agilent GC front inlet Includes supporting rod N20 (1 set), and supporting plate set N20 (1 set)	1 set	
AS1-K782	AS-2020E Installation Kit for Agilent 8890/7890GC back inlet	For Agilent GC back inlet Includes Support attachment N20 (1 set), M3x6 screws (2 ea), Support 2 fixing screw (1 ea), and AS Spacer 30 (2 ea)	1 set	
AS1-K782SP1	AS-2020E Installation Kit for Agilent 8890 GC SP-1	Includes Stand for Auto-Shot Sampler 80 mm (2 ea), AS Supporting Rod N20 SP-1(1 set), and Supporting Plate Set N20 (1 set)	1 set	

9. Auto-Shot Sampler (AS-2020E/1020E)

Installation Kit for Major GCs (AS-2020E)



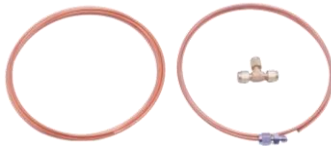

P/N (part number)	Part name	Specification	Qty	Part
AS1-K787	AS-2020E Sideways Installation Kit for Agilent 8890/7890	Includes supporting plate set N20 (1 set), Outer cover for AS-2020E sideways installation (1 ea), Stand for Auto-Shot Sampler 60 mm (1 ea), AS 2020E Sample Cup Recovery Chute for Agilent Sideways Installation (1 ea), and AS Support Attachment 1 (1 set), PY-3030 sideways installation kit (PY-K7894) is required.	1 set	
AS1-K905	AS-2020E Mounting Kit for Thermo TRACE GC1600/1610/1300 /1310	Includes Supporting Rod N20 (1 set), Supporting plate set N20 (1 set), and 40 mm extension stand for AS (1 ea)	1 set	

Miscellaneous Parts

P/N (part number)	Part name	Specification	Qty	Part
AS1-1531	Sample Cup Inspector		1 ea	
AS1-4111	Valve Control Cable	For AS-1020E Gas reservoir valve control cable, DC24V 3 poles, 2 m	1 ea	
AS1-4112	Valve Control Cable N20	For AS-2020E Gas reservoir valve control cable, DC24V 3 poles, 2 m	1 ea	
AS1-K040	Tubing Kit	for AS-2020E/1020E, includes each 1 pcs of 1/8" copper tube 1.5 m and 3 m, 1/8" union (no ferrule), 1/8" TEE union	1 set	
PY1-EC80F	Eco-Cup LF	4 mm o.d. x H 8 mm , 80 µL, made of deactivated stainless steel	100 ea	





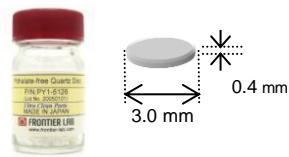
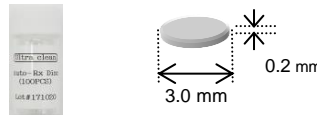
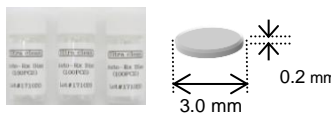

9. Auto-Shot Sampler (AS-2020E/1020E)

Miscellaneous Parts



P/N (part number)	Part name	Specification	Qty	Part
PY1-3533	ITF Union ASN	Interface union assembly for use with Auto-Shot Sampler, deactivated, compatible with PY-2020/3030, Carrier gas union set, wrench 6 mm	1 ea	
PY1-3711	Eco-Cup Stand 10	For Eco-Cup LF and Eco-Cup G/GQ, for 10cups	1 ea	
PY1-5111	Fine Quartz Wool 2g	2 g	1 ea	
PY1-5121	Phthalate-free Quartz Wool	Phthalate-free quartz wool 1.0g (200 mg per a vial, 5 vials set), with test certificate (less than 1 ppm: DIBP, DBP, BBP, DEHP, DNOP / less than 5 ppm: DINP, DIDP)	1 set	
PY1-5126	Phthalate-free Quartz Disc	Phthalate-free Quartz Disc 125 mg (1 bottle), with test certificate (less than 1 ppm: DIBP, DBP, BBP, DEHP, DNOP / less than 5 ppm: DINP, DIDP)	1 ea	
PY1-7787	Auto-Rx Disc 100	Allow to use AS-1020E for reactive pyrolysis	100 ea	
PY1-7788	Auto-Rx Disc 300	Allow to use AS-1020E for reactive pyrolysis	300 ea (100 x 3 vials)	

10. Carrier Gas Selector (CGS-1050Ex)

Tubing Kit

P/N (part number)	Part name	Specification	Qty	Part
CG1-1700	CGS Tubing Kit for Shimadzu GC-17A	CGS-1050Ex tubing kit for Shimadzu GC-17A	1 set	
CG1-2010	CGS Tubing Kit for Shimadzu GC-2010/2030	CGS-1050Ex tubing kit for Shimadzu GC-2010/2030	1 set	
CG1-3800	CGS Tubing Kit for Varian GC3800/450	CGS-1050Ex tubing kit for Varian GC3800/450	1 set	
CG1-5800	CGS Tubing Kit for PerkinElmer Clarus 580/680	CGS-1050Ex tubing Kit for PerkinElmer Clarus 580/680	1 set	
CG1-6800	CGS Tubing Kit for Agilent GC7890/6890	CGS-1050Ex tubing kit for Agilent GC7890/6890	1 set	
CG1-9001	CGS Tubing Kit for TRACE GC Ultra	CGS-1050Ex tubing kit for TRACE GC Ultra	1 set	
CG1-9003	CGS Tubing Kit for TRACE 1600/1610/1300/1310GC	CGS-1050Ex tubing kit for TRACE 1600/1610/1300/1310GC	1 set	



Miscellaneous Parts

P/N (part number)	Part name	Specification	Qty	Part
CG1-4020	CGS Valve Control Cable	CGS-1050Ex valve control cable for PY-3030D/S	1 ea	
PY1-7001	AC Power Cable 100V for UL standard	AC power cable 100-120V for UL standard	1 ea	



11. Micro UV Irradiator (UV-1047Xe/UV-1048E)

11.1 Micro UV Irradiator Xe (UV-1047Xe)





UV Light Source Lamp

P/N (part number)	Part name	Specification	Qty	Part
UV1-7105	Xenon Arc Lamp (contains Hg)		1 ea	
UV1-7106	Xenon Arc Lamp (contains no Hg)		1 ea	

UV Sampler Parts

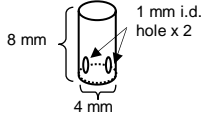
P/N (part number)	Part name	Specification	Qty	Part
UV1-3801	UV Sampler		1 ea	 *UV fiber Xe is not included
UV1-3802	UV Sampler Stand	Stand for UV sampler	1 ea	
UV1-7012	UV Fiber Xe		1 ea	

Miscellaneous Parts

P/N (part number)	Part name	Specification	Qty	Part
PY1-EC80UV	Eco-Cup UV	Flow through type, 1 mm i.d. hole at both sides, 4 mm o.d. x H 8 mm , 80 µL	20 ea	  1 mm i.d. hole x 2 8 mm 4 mm
PY1-7802	Communication Cable	RS-232C, D-sub 9 pins, female, reverse	1 ea	
UV1-K001	UV Tube Kit	A set of Air Tube Set (UV1-K101) and Extension Tube Set (UV1-K104)	1 set	
UV1-K101	Air Tube Set	Includes each 1 of 1/8" copper tube (3 m), 1/8" union, 1/8"nut, back ferrule and front ferrule	1 set	

11. Micro UV Irradiator (UV-1047Xe/UV-1048E)





11.1 Micro UV Irradiator Xe (UV-1047Xe)

Miscellaneous Parts

P/N (part number)	Part name	Specification	Qty	Part
UV1-K104	Extension Tube Set	Includes each 2 pcs of 1/16-inch SS tube (1.5 m) and union sets for carrier gas connection, 1 set	1 set	
UV1-4001	Polystyrene sample for UV Irradiator Performance Evaluation	3 mm diameter disc	30 ea	
UV1-4201	UV Sampler Adjusting Tool		1 ea	
UV1-7108	Fiber Clamp A		1 ea	
UV1-7201	Dewar 350	Liquid nitrogen container, 350 mL	1 ea	
UV1-7501	Dewar Holder	Holder to prevent the liquid nitrogen container fall	1 ea	
UV1-7807	USB-Serial converter	USB-Serial converter	1 ea	
UA1-30M-0.5F	Ultra ALLOY® Capillary column	dimethyl polysiloxane, 0.25mm id, 30m, 0.5um	1 ea	

11. Micro UV Irradiator (UV-1047Xe/UV-1048E)

11.2 Multi-Sample UV Irradiator (UV-1048E)

P/N (part number)	Part name	Specification	Qty	Part
PY1-7001	AC Power Cable 100V for UL standard	AC power cable 100-120V for UL standard	1 ea	
UV1-7015	UV Fiber bundle	For UV-1048E	1 ea	
UV1-7016	UV Fiber bundle connector	For UV-1048E	1 ea	
UV1-7017	Sample Holder 18	For UV-1048E	1 ea	

12. micro-Reactor (Rx-3050TR, Rx-3050SR)

12.1 Consumable parts set : a set of consumable parts for one year

Rx Consumable Parts Set

Rx Consumable Parts Set TR

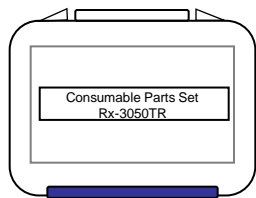

P/N: Rx1-K040TR

For Tandem micro-Reactor Rx-3050TR,
1 set

Contents of Rx Consumable Parts Set TR	Qty
1) ITF Needle Set N	3 ea
2) O-ring P-6R	5 ea
3) Fine Quartz Wool (0.5g)	1 ea
4) Graphite Vespel Ferrule	10 ea
5) Rx ITF Needle B Set	3 ea
6) Rx Deactivated SS Tube A	3 ea
7) Rx Blank Quartz Insert A	10 ea
8) High temperature-resistant O-ring P4	10 ea

※ Use the following part numbers when ordering the parts individually. The quantities of each parts may differ from the Consumable Parts Set. The quantities of the parts contained in the Consumable Parts Set are shown in the list above.

No.	P/N (part number)	Part name	Specification	Qty	Part
1	PY1-1274	ITF Needle Set N	Deactivated needle for PY-3030, PY-2020 and Rx-3050	3 ea	
2	PY1-2021*	O-ring P-6R <small>*Replacement of PY1-2017 (O-ring P-6W).</small>	Pyrolysis tube sealing Red silicon rubber	10 ea	
3	PY1-5112	Fine Quartz Wool, 0.5g	0.5 g	1 ea	
4	PY1-7911	Graphite Vespel Ferrule	Graphite vespel ferrule, 6mm hole i.d., for quartz pyrolysis tube	5 ea	
5	Rx1-1279	Rx ITF Needle B Set	For Tandem micro reactor, Rx ITF needle B, o.d.1/16", with nut-ferrule	3 ea	
6	Rx1-3540	Rx Deactivated SS Tube A	For Tandem/Single micro reactor, 6 mm o.d., 120 mm length, deactivated stainless steel	1 ea	
7	Rx1-3541	Rx Blank Quartz Insert A	3 mm i.d., 4 mm o.d., x L 78 mm	5 ea	
8	Rx1-3557	High temperature-resistant O-ring (P4)	Fluorine rubber, black	10 ea	

12. micro-Reactor (Rx-3050TR, Rx-3050SR)

12.1 Consumable parts set : a set of consumable parts for one year

Rx Consumable Parts Set

Rx Consumable Parts Set SR

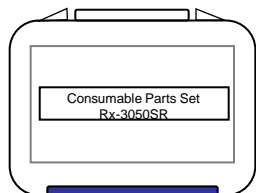







P/N: Rx1-K040SR

For Single micro-Reactor Rx-3050SR,

1 set

Contents of Rx Consumable Parts Set SR	Qty
1) ITF Needle Set N	3 ea
2) Fine Quartz Wool 0.5g	1 ea
3) Graphite Vespel Ferrule	5 ea
4) Rx Deactivated SS Tube A	3 ea
5) Rx Blank Quartz Insert A	10 ea
6) O-ring P6	10 ea
7) High temperature-resistant O-ring (S4)	10 ea

※ Use the following part numbers when ordering the parts individually. The quantities of each parts may differ from the Consumable Parts Set. The quantities of the parts contained in the Consumable Parts Set are shown in the list above.

No.	P/N (part number)	Part name	Specification	Qty	Part
1	PY1-1274	ITF Needle Set N	Deactivated needle for PY-3030, PY-2020 and Rx-3050	3 ea	
2	PY1-5112	Fine Quartz Wool 0.5g	0.5 g	1 ea	
3	PY1-7911	Graphite Vespel Ferrule	6 mm hole i.d., for interface	5 ea	
4	Rx1-3540	Rx Deactivated SS Tube A	6 mm i.d. x L 120 mm	1 ea	
5	Rx1-3541	Rx Blank Quartz Insert A	3 mm i.d., 4 mm o.d., x L 78 mm	5 ea	
6	Rx1-3551	O-ring P6	Fluorine rubber, black	10 ea	
7	Rx1-3556	High temperature-resistant O-ring (S4, black)	Fluorine rubber, black	10 ea	

12. micro-Reactor (Rx-3050TR, Rx-3050SR)

12.2 Tandem micro-Reactor related parts

1st and 2nd Reactor furnace parts

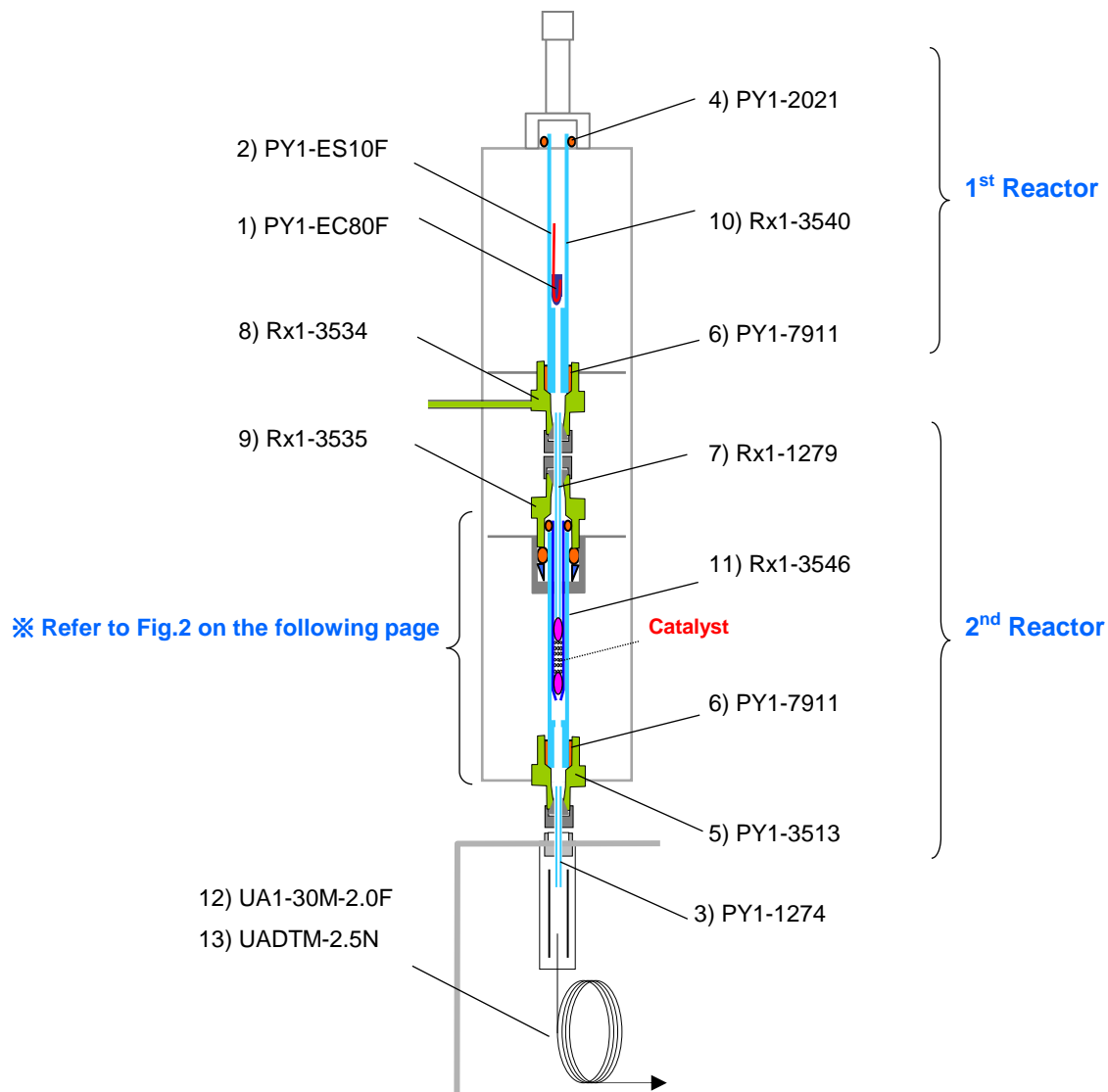

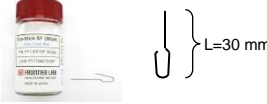













Fig.1 Visual list of consumables

12. micro-Reactor (Rx-3050TR, Rx-3050SR)

12.2 Tandem micro-Reactor related parts

No.	P/N (part number)	Part name	Specification	Qty	Part
1	PY1-EC80F	Eco-Cup LF	4 mm o.d. x H 8 mm , 80 μ L, made of stainless steel	100 ea	
2	PY1-ES10F	Eco-Stick SF	For stainless steel Eco-Cups, L 30 mm , for Single-shot	50 ea	
3	PY1-1274	ITF Needle Set N	Deactivated needle for PY-3030 and Rx-3050	3 ea	
4	PY1-2021*	O-ring P-6R *Replacement of PY1-2017 (O-ring P-6W).	Pyrolysis tube sealing Red silicon rubber	10 ea	
5	PY1-3513	ITF Union N	With nut	1 ea	
6	PY1-7911	Graphite Vespel Ferrule	6 mm hole i.d., for interface	5 ea	
7	Rx1-1279	Rx ITF Needle B Set	1/16" o.d., with nut and ferrule	3 ea	
8	Rx1-3534	Rx ITF Union A	With reaction gas feed tube	1 ea	
9	Rx1-3535	Rx ITF Union B	1/16" – 1/4"	1 ea	
10	Rx1-3540	Rx Deactivated SS Tube A	For Tandem/Single micro reactor, 6 mm o.d., 120 mm length, deactivated stainless steel	1 ea	
11	Rx1-3546	Rx Deactivated SS Tube B	For 2nd reactor of Tandem micro reactor, 6 mm o.d., 120 mm length, deactivated stainless steel	1 ea	
12	UA1-30M-2.0F	Ultra ALLOY® Capillary Column	dimethylpolysiloxane, 30 m, 0.25 mm i.d., 2.0 μ m	1 ea	
13	UADTM-2.5N	EGA Capillary Tube	For Evolved gas analysis, 2.5 m , 0.15 mm i.d.	1 ea	

12. micro-Reactor (Rx-3050TR, Rx-3050SR)

12.2 Tandem micro-Reactor related parts

1st and 2nd Reactor furnace parts

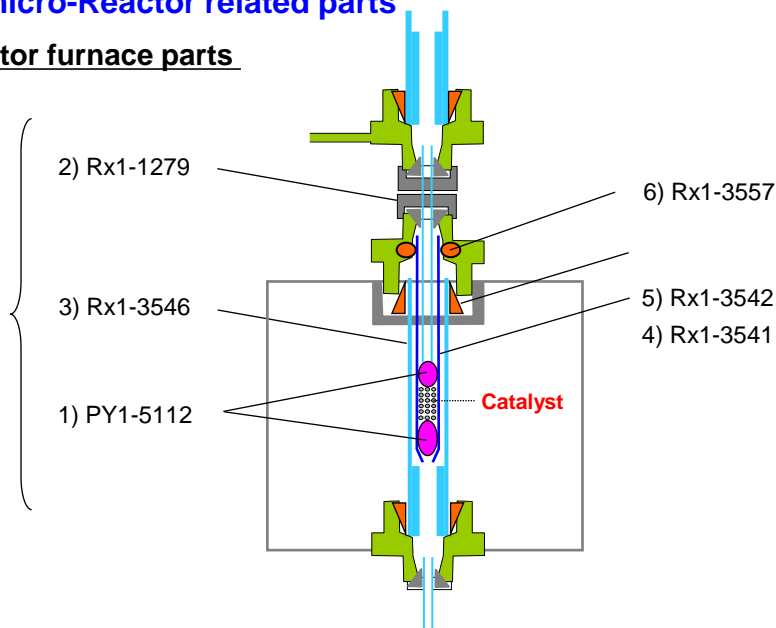







Fig. 2 Visual list of consumables

No.	P/N (part number)	Part name	Specification	Qty	Part
1	PY1-5112	Fine Quartz Wool 0.5g	0.5 g	1 ea	
2	Rx1-1279	Rx ITF Needle B Set	1/16" o.d., with nut and ferrule	3 ea	
3	Rx1-3546	Rx Deactivated SS Tube B	For 2nd reactor of Tandem micro reactor, 6 mm o.d., 120 mm length, deactivated stainless steel	1 ea	
4	Rx1-3541	Rx Blank Quartz Insert A	3 mm i.d., 4 mm o.d., x L78 mm	5 ea	
5	Rx1-3542	Rx ZMS-5 Quartz Insert A	3 mm i.d., 4 mm o.d., x L 78 mm	1 ea	
6	Rx1-3557	High temperature- resistant O-ring (P4)	Fluorine rubber, Black	10 ea	

12. micro-Reactor (Rx-3050TR, Rx-3050SR)

12.3 Single micro-Reactor related parts

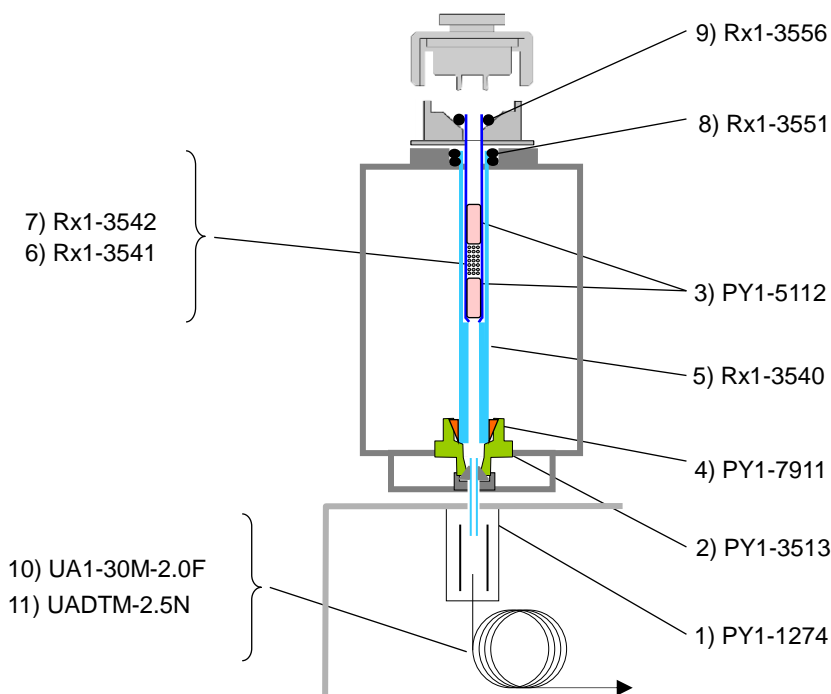









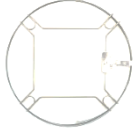

Fig. 3 Visual list of consumables

No.	P/N (part number)	Part name	Specification	Qty	Part
1	PY1-1274	ITF Needle Set N	Deactivated needle for PY-3030 and Rx-3050	3 ea	
2	PY1-3513	ITF Union N	With nut	1 ea	
3	PY1-5112	PY1-5112	Fine Quartz Wool 0.5g	0.5 g	
4	PY1-7911	Graphite Vespel Ferrule	6 mm hole i.d., for interface	5 ea	
5	Rx1-3540	Rx Deactivated SS Tube A	For Tandem/Single micro reactor, 6 mm o.d., 120 mm length, deactivated stainless steel	1 ea	
6	Rx1-3541	Rx Blank Quartz Insert A	3 mm i.d., 4 mm o.d., x L78 mm	5 ea	

12. micro-Reactor (Rx-3050TR, Rx-3050SR)

12.3 Single micro-Reactor related parts

No.	P/N (part number)	Part name	Specification	Qty	Part
8	Rx1-3551	O-ring P6	Fluorine rubber, black	10 ea	
9	Rx1-3556	High temperature-resistant O-ring (S4, black)	Fluorine rubber, black	10 ea	
10	UA1-30M-2.0F	Ultra ALLOY [®] Capillary Column	dimethylpolysiloxane, 30 m, 0.25 mm i.d., 2.0 um	1 ea	
11	UADTM-2.5N	EGA Capillary Tube	For Evolved gas analysis, 2.5 m , 0.15 mm i.d.	1 ea	

12. micro-Reactor (Rx-3050TR, Rx-3050SR)

12.4 micro-Reactor related parts

P/N (part number)	Part name	Specification	Qty	Part
PY1-EH10AL	Eco-Stand AL	Eco-Cup stand for 1 cup, for all Eco-Cups, made of aluminum	5 ea	
PY1-EP55F	Eco-Pickup F	For stainless steel Eco-Cup recovery, L 135 mm	5 ea	
PY1-2025	Septum	For liquid sampler	20 ea	
PY1-3563	Interface Cover 3030A	Interface cover for EGA/ PY-3030D, PY-3030S, Rx-3050TR, Rx-3050SR, includes set screw (3 ea)	1 set	
PY1-7131	Level Vial		1ea	
PY1-7618	Furnace purge gas restrictor B	Stainless tube (0.47 mm o.d., 0.15 mm i.d, 1.0 m) 1 ea, 1/16-1/8-inch union 2 ea, inlet/outlet septum 1 ea, banding band 2 ea, purge gas holder	1 set	
Rx1-K033	Rx Piping Kit A	1/16-inch SS tube, 1.5m, 0.8mm i.d., 1/8-inch union (SS, 1 ea), 1/8-inch nut SS, 3ea), 1/8-inch back ferrule (SS, 3 ea), rubber seal with hole(3 ea)	1 set	
UV1-7201	Dewar 350	Liquid nitrogen container, 350 mL	1 ea	
UV1-7501	Dewar Holder	Holder to prevent the liquid nitrogen container fall	1 ea	

12. micro-Reactor (Rx-3050TR, Rx-3050SR)



12.2 1st and 2nd Reactor related parts

Control Cable (for connection between micro-Reactor and controller)

Depending on the types of micro-Reactor, different the furnace control cable is used.

Please make sure to select a part compatible with your micro-Reactor.

Rx-3050TR/SR

P/N (part number)	Part name	Specification	Qty	Part
Rx1-7806	1st reactor control cable	For Tandem / Single micro-Reactor, 1st reactor control cable, 1.5m	1 ea	
Rx1-7808	Tandem micro reactor control cable	For Tandem micro-Rreactor, 1.5m	1 ea	



12. micro-Reactor (Rx-3050TR, Rx-3050SR)

12.4 micro-Reactor related parts

1st Reactor furnace parts (others)

P/N (part number)	Part name	Specification	Qty	Part
PY1-1036	Liquid Injection Sampler A	Liquid sampler for all pyrolyzers and micro reactors	1 ea	
PY1-3631	Storage Stand 30A	One piece type	1 ea	
Rx1-1040	High Pressure Solid Sampler	For Rx-3050HP /MP, for high /medium pressure	1 ea	
Rx1-2023	High Pressure Solid Sampler Stand		1 ea	
Rx1-2501	Rx Tandem Reactor Cover A		1 ea	
Rx1-3579	Rx Heat Sink Adapter Set B	For Tandem micro reactor, Heat Sink Adapter Set	1 set	

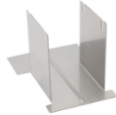
2nd Reactor furnace parts (others)

P/N (part number)	Part name	Specification	Qty	Part
PY1-3563	ITF Cover 3030A	Interface cover for EGA/PY-3030D, PY-3030S, Rx-3050TR, Rx-3050SR, includes set screw(3ea)	1 set	
PY1-3631	Storage Stand 30A	One piece type	1 ea	
Rx1-2504	Rx Interface Cover B	For Tandem micro reactor, Cover for interface between 1st and 2nd reactor	1 ea	

12. micro-Reactor (Rx-3050TR, Rx-3050SR)

12.4 micro-Reactor related parts

Controller parts

P/N (part number)	Part name	Specification	Qty	Part
PY1-3751	USB Cable Fixing Bracket		1 ea	
PY1-6034	Noise Filter for AC Power Cable		1 ea	
PY1-7001	AC Power Cable 100V for UL standard	100 – 120V	1 ea	
PY1-7002	AC Power Cable 200V for VDE standard	200 – 240V	1 ea	
PY1-7612	Cooling Gas Tube	For cooling gas, 4 mm o.d., 2 mm i.d., 1.5 m, 1 ea, *refer to PY1-7801(Cooling Gas Connecting Tube) if a quick connector is required.	1 ea	
PY1-7613	Cooling Gas Tube (with restrictor)	With restrictor, 4 mm o.d., 2 mm i.d., 1.5 m	1 ea	
PY1-7614	Nylon tube branching adapter	For Tandm micro reactor cooling gas franching, 3-way, 4 mm o.d. Nylon tube	1 ea	
PY1-7801	Cooling Gas Connecting Tube	For cooling gas of pyrolyzer, with a quick connector 1.5 m, 1 ea	1 ea	
PY1-7805	USB Cable	2 m, type A male – type B male	1 ea	

12. micro-Reactor (Rx-3050TR, Rx-3050SR)

12.4 micro-Reactor related parts

Tool Set





Rx Tool Set A P/N: Rx1-K050, 1 set

Contents of Rx Tool Set A	Qty
1) Hex Screw Driver 2	1 ea
2) Hex Screw Driver 2.5	1 ea
3) Tweezers	1 ea
4) Double Head Wrench (12/13 mm)	1 ea
5) Double Head Wrench (6/8 mm)	2 ea

Rx Tool Set B P/N: Rx1-K051, 1 set

Contents of Rx Tool Set B	Qty
1) Hex Screw Driver 2	1 ea
2) Tweezers	1 ea
3) Double Head Wrench (12/13 mm)	1 ea
4) Double Head Wrench (6/8 mm)	2 ea

※ Use the following part numbers when ordering the parts individually. The quantities of each parts may differ from the Rx Tool Set. The quantities of the parts contained in the Rx Tool Set are shown in the list above.

No.	P/N (part number)	Part name	Specification	Qty	Part
1	PY1-7111	Hex Screw Driver (2 mm)	2.0 mm	1 ea	
2	PY1-7113	Hex Screw Driver (2.5 mm)	2.5 mm	1 ea	
3	PY1-7141	Tweezers	L 125 mm	1 ea	
4	Rx1-3531	Double Head Wrench (12/13 mm)	12/13 mm	1 ea	
5	Rx1-3532	Double Head Wrench (6/8 mm)	6-8 mm	1 ea	

12. micro-Reactor (Rx-3050TR, Rx-3050SR)

12.4 micro-Reactor related parts

Vent-free GC/MS Adapter

Vent-free GC/MS Adapter N-50

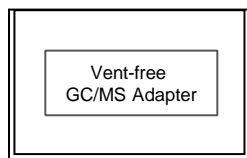









P/N: MS402280

For Agilent, Shimadzu, JEOL and

Thermo TRACE1600/1610/1300/1310, 1 set

Contents of MS402280		Qty
1)	Plug Nut B	1 set
2)	VF Metal Ferrule D	10 ea
3)	VF Tube N-50	2 ea
4)	VF Holder N	1 ea
5)	VF Nut B	1 ea
6)	VF Nut C	1 ea
7)	Column Nut	2 ea
8)	Double Head Wrench (6/8 mm)	2 ea
9)	Operation Manual	1 ea

※ Use the following part numbers when ordering the parts individually. The quantities of each parts may differ from the Vent-free GC/MS Adapter N-50. The quantities of the parts contained in the Vent-free GC/MS Adapter N-50 are shown in the list above.

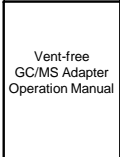
No.	P/N (part number)	Part name	Specification	Qty	Part
1	MS402168	Plug Nut B	Use to plug the VF tube	1 set	
2	MS402167	VF Metal Ferrule D	VF Metal Ferrule D for column connection	20 ea	
3	MS402200	VF Tube N-50	Includes Vent-free tube N (0.15 mm id / 50 cm, 1 ea), VF spacer, VF metal ferrule D (2 ea), VF nut B and VF nut C	1 set	
4	MS402210	VF Holder N	Use with VF Tube N, consists of holder and fixing bracket	1 set	
5	MS402286	VF Nut B	For the interface between MS and VF tube	3 ea	
6	MS402287	VF Nut C	For the interface between VF Holder N and VF tube	3 ea	
7	MS604234	Column Nut		1 ea	
8	Rx1-3532	Double Head Wrench (6/8 mm)	6-8 mm	1 ea	
9	-	Operation Manual	※Not for sale. This can be downloaded from Frontier Lab's website for free.	-	

12. micro-Reactor (Rx-3050TR, Rx-3050SR)

12.4 micro-Reactor related parts

Vent-free GC/MS Adapter

Vent-free GC/MS Adapter N-70

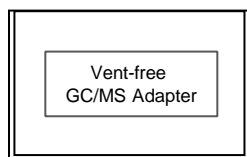









P/N: MS402290

For Thermo TRACE Ultra and Focus GC, 1 set

Contents of MS402295		Qty
1)	Plug Nut B	1 set
2)	VF Metal Ferrule D	10 ea
3)	VF Tube N-70PE	2 ea
4)	VF Holder N	1 ea
5)	VF Nut B	1 ea
6)	VF Nut C	1 ea
7)	Column Nut	2 ea
8)	Double Head Wrench (6/8 mm)	2 ea
9)	Operation Manual	1 ea

※ Use the following part numbers when ordering the parts individually. The quantities of each parts may differ from the Vent-free GC/MS Adapter N-70. The quantities of the parts contained in the Vent-free GC/MS Adapter N-70 are shown in the list above.

No.	P/N (part number)	Part name	Specification	Qty	Part
1	MS402168	Plug Nut B	Use to plug the VF tube	1 set	
2	MS402167	VF Metal Ferrule D	VF Metal Ferrule D for column connection	20 ea	
3	MS402184	VF Nut 1/16	For connecting VF tube to Bruker/Thermo MS interface. 1/16-inch SS, For Thermo Fisher MS	5 ea	
4	MS402201	VF Tube N-70	Includes Vent-free tube N (0.15 mm id / 70 cm, 1 ea), VF spacer, graphite vespel ferrule, VF metal ferrule, 1/16 nut (SS) and VF nut C For Thermo Fisher MS	1 ea	
5	MS402210	VF Holder N	Use with VF Tube N, consists of holder and fixing bracket	1 set	
6	MS402287	VF Nut C	For the interface between VF Holder N and VF tube	3 ea	
7	MS604234	Column Nut		1 ea	
8	PY1-7971	Graphite Vespel Ferrule 05	0.5 mm hole i.d.	10 ea	
9	Rx1-3532	Double Head Wrench (6/8 mm)	6-8 mm	1 ea	
10	-	Operation Manual	※Not for sale. This can be downloaded from Frontier Lab's website for free.	1 ea	



13. Cryogenic Mill (IQ MILL-2070)

Sample Container related parts





P/N (part number)	Part name	Specification	Qty	Part
IQ1-2001	Insulation Container	Polycarbonate	1 ea	
IQ1-2011	Sample Container L-Ti	Titanium, two O-rings (S-18R) included, 7 mL, no lids	1 ea	
IQ1-2012	Sample Container L-SS	Stainless steel, two O-rings (S-18R) included, 7 mL, no lids	1 ea	
IQ1-2013	Sample Container S-SS	Stainless steel, one O-ring (S-10R) included, 2 mL, no lid	1 ea	
IQ1-2021	Insert Tube	Polycarbonate tube, inserting into sample container L series	10 ea	
IQ1-2026	Sample Container S-SS Spacer	Polycarbonate, inserted into insulation container with Sample Container S-SS	3 ea	
IQ1-2031	Sample Container Lid L-Ti	Titanium, top and bottom lids for sample container L-Ti	2 ea	
IQ1-2032	Sample Container Lid L-SS	Stainless steel, top and bottom lids for sample container L-SS	2 ea	
IQ1-2033	Sample Container Lid S-SS	Stainless steel, lid for sample container S-SS	1 ea	
IQ1-2042*	O-ring (S-18R) <small>*Successor of P/N: IQ1-2041</small>	Red, Silicone, prevents loosening the lid of Sample container L series	20 ea	

13. Cryogenic Mill (IQ MILL-2070)

Sample Container related parts









P/N (part number)	Part name	Specification	Qty	Part
IQ1-2043	O-ring (S-10R)	Red, Silicone, prevents loosening the lid of Sample Container S-SS	20 ea	
IQ1-2071	Performance Evaluation PS	Polystyrene Sample for IQ MILL Performance Evaluation (1~2 mm), 1 g	1 ea	

Sample Container set parts

P/N (part number)	Part name	Specification	Qty	Part
IQ1-2051	Sample Container L-Ti Set	A set of Sample Container L-Ti (P/N:IQ1-2011) and Sample Container Lid L-Ti (P/N:IQ1-2031)	1 set	
IQ1-2052	Sample Container L-SS Set	A set of Sample Container L-SS (P/N:IQ1-2012) and Sample Container Lid L-SS (P/N:IQ1-2032)	1 set	
IQ1-2053	Sample Container S-SS Set	A set of Sample Container S-SS (P/N:IQ1-2013), Sample Container Lid S-SS (P/N:IQ1-2033), and Sample Container S-SS Spacer (P/N: IQ1-2026)	1 set	
IQ1-2062	Sample Container L-SS Starter Kit	A set of Insulation Container (IQ1-2001, 2 ea), Sample Container L-SS Set (IQ1-2052, 2 set), Insert Tube (IQ1-2021, 1 set), O-ring S-18R (IQ1-2042, 1 set)	1 set	

13. Cryogenic Mill (IQ MILL-2070)

Grinding Ball related parts



P/N (part number)	Part name	Specification	Qty	Part
IQ1-WC12	WC-12 Grinding Ball	Tungsten carbide (WC), 12 mm sphere	20 ea	
IQ1-WC10	WC-10 Grinding Ball	Tungsten carbide (WC), 10 mm sphere	20 ea	
IQ1-WC06	WC-6 Grinding Ball	Tungsten carbide (WC), 6 mm sphere	50 ea	
IQ1-WC05	WC-5 Grinding Ball	Tungsten carbide (WC), 5 mm sphere	50 ea	
IQ1-WC03	WC-3 Grinding Ball	Tungsten carbide (WC), 3 mm sphere, 30 g	ca. 150 ea	
IQ1-WC02	WC-2 Grinding Ball	Tungsten carbide (WC), 2 mm sphere, 13 g	ca. 200 ea	
IQ1-WC01	WC-1 Grinding Ball	Tungsten carbide (WC), 1 mm sphere, 12 g	ca. 1,500 ea	
IQ1-ZR12	Zr-12 Grinding Ball	Zirconia (ZrO ₂), 12 mm sphere	30 ea	
IQ1-ZR10	Zr-10 Grinding Ball	Zirconia (ZrO ₂), 10 mm sphere	30 ea	
IQ1-ZR06	Zr-6 Grinding Ball	Zirconia (ZrO ₂), 6 mm sphere, 100 g	ca. 150 ea	
IQ1-ZR05	Zr-5 Grinding Ball	Zirconia (ZrO ₂), 5 mm sphere, 200 g	ca. 500 ea	
IQ1-ZR03	Zr-3 Grinding Ball	Zirconia (ZrO ₂), 3 mm sphere, 200 g	ca. 2,000 ea	
IQ1-ZR02	Zr-2 Grinding Ball	Zirconia (ZrO ₂), 2 mm sphere, 200 g	ca. 8,000 ea	
IQ1-ZR01	Zr-1 Grinding Ball	Zirconia (ZrO ₂), 1 mm sphere, 200 g	ca. 60,000 ea	

13. Cryogenic Mill (IQ MILL-2070)

Grinding Ball related parts

P/N (part number)	Part name	Specification	Qty	Part
IQ1-SS12R	SS Grinding Rod 12	Carbide stainless steel, 12 mm i.d., 20 mm length	3 ea	

Other parts

P/N (part number)	Part name	Specification	Qty	Part
IQ1-3001	High Elastic Belt-01	Highly durable elastic belt	20 ea	
IQ1-4001	Cooling Holder	Used to cool a set of three insulation containers in a colling container	1 ea	
IQ1-4002	Cooling Container	Liquid nitrogen vessel used to cool sample containers	1 ea	
IQ1-4011	Sieve Set	A set of 40 and 60 mesh sieves and a pan set	1 set	
IQ1-4021	Tongs	Used to remove cooled sample containers from liquid nitrogen	1 ea	

13. Cryogenic Mill (IQ MILL-2070)

Power Cable (Pyrolyzer and Accessory)

Depending on the country / region, different power cable is used.

Please make sure to select a part compatible with your country / region.

P/N (part number)	Part name	Specification	Qty	Part
PY1-7001	AC Power Cable 100V for UL standard	AC Power Cable 100-120V for UL standard, includes noise filter 09 (1 ea)	1 ea	
PY1-7022	AC Power Cable 200VF for VDE standard	AC Power Cable 200-240V for VDE standard, includes noise filter 13 (1 ea)	1 ea	
PY1-7025	(For China only) AC Power Cable 200VF for CCC standard	(For China only) AC Power Cable 200-240V for CCC standard, include noise filter 13 (1ea)	1 ea	
PY1-7032	(For Korea only) AC Power Cable 200VF for KC standard	(For Korea only) AC Power Cable 200-240V, 10A/AC250V, 2 m, for KC standard, includes noise filter 13 (1 ea)	1 ea	
PY1-7035	(For UK only) AC Power Cable 200VF for BS standard	(For UK only) AC Power Cable 200-240V for BS standard, include noise filter 13 (1ea)	1 ea	

